



V1504

VERTICAL PLATFORM LIFT

PLANNING GUIDE

Applicable Codes:

ASME A17.1

ASME A18.1

CAN/CSA B355

CAN/CSA B613

Copyright © 2020
Savaria Concord Lifts, Inc.
All rights reserved.

Printed in Canada

Purpose of This Guide

This guide assists architects, contractors, and lift professionals to incorporate the V1504 Vertical Platform Lift into a residential or public building design. The design and manufacture of the V1504 Vertical Platform Lift meets the requirements of the following codes and standards:

- ASME A18.1-2003 Section 2 (Public)
- ASME A18.1-2005 Section 2 (Public)
- ASME A18.1-2008 Section 2 (Public)
- ASME A18.1-2011 Section 2 (Public)
- ASME A18.1-2014 Section 2 (Public)
- ASME A18.1-2017 Section 2 (Public)
- ASME A18.1-2003 Section 5 (Private)
- ASME A18.1-2005 Section 5 (Private)
- ASME A18.1-2008 Section 5 (Private)
- ASME A18.1-2011 Section 5 (Private)
- ASME A18.1-2014 Section 5 (Private)
- ASME A18.1-2017 Section 5 (Private)
- ASME A17.1-1996 Section 20 (Public)
- ASME A17.1-1996 Section 21 (Private)
- CAN/CSA B355 S1-02 (Public)
- CAN/CSA-B355-09 (Public)
- CAN/CSA B613-2000 (Private)

We recommend that you contact your local authority having jurisdiction to ensure that you adhere to all local rules and regulations pertaining to vertical platform lifts.

IMPORTANT: This Planning Guide provides nominal dimensions and specifications useful for the initial planning of a vertical platform lift project. Dimensions and specifications are subject to change without notice due to continually evolving code and product applications.

Before beginning actual construction, please consult Savaria or the authorized Savaria dealer in your area to ensure you receive your site-specific installation drawings with the dimensions and specifications for your project.

Visit our website for the most recent V1504 drawings and dimensions.

How to Use This Guide

- 1 Determine your client's intended use of the lift.
- 2 Determine the local code requirements.
- 3 Determine the site installation parameters.
- 4 Determine the cab type and hoistway size requirements.
- 5 Plan for electrical requirements.

History

April 6, 2010 - Initial release

May 16, 2011 - Updated "Travel speed" in Specifications table to 20 ft/min (0.1 m/s)

June 17, 2011 - Added 24V battery backup to Options to Specifications table on page 5

July 8, 2013 - Added Noise Level to Specifications table on page 4

July 29, 2013 - Added optional 80" cab wall height to Specifications table on page 4

October 7, 2013 - Added seat capacity to Specifications table on page 4

November 12, 2013 - Revised drawings on pages 12 through 26 to include 42"-wide platforms

December 5, 2013 - Revised enclosure drawings on pages 20 through 24

February 12, 2014 - Added seat dimensions on page 27

March 18, 2014 - Revised motor/drive information in Specifications table on page 5

April 7, 2014 - Revised drawings on pages 20-24

April 29, 2014

May 29, 2014 - Added NOTE to page 27 specifying max seat capacity; Changed motor/drive specification on page 4 from 1 HP to 3 HP

June 9, 2014 - Added Remote Controller/Pump Box dimensions on page 28

June 25, 2014 - Added door and gate drawings - pages 25 to 36
July 28, 2014 - Added DuraSwing operator drawings - pages 37 to 40
September 11, 2014 - Removed section "Additional Branch Circuit" from page 43
November 5, 2014 - Revised Applicable Codes on page 3
January 20, 2015 - Added new 2014 code in section above
February 17, 2015 - Revised drawings on pages 13 to 19
September 24, 2015 - Added Daily Cycle to specifications table on page 4
March 1, 2016 - Revised Motor/drive specification in table on page 4
June 3, 2016 - Added spec for Additional Branch Circuit on page 43
July 14, 2016 - Added new Prodoor drawing on page 33
August 8, 2016 - Revised voltage in Standard Features on Specifications table on page 4
February 9, 2017 - Added spec for distance between landings to specs table on page 4
February 16, 2017 - Added spec for temperature to specs table on page 4
April 4, 2017 - Added information for Branch Circuit for Hoistway Pit Lighting and Receptacles to Provisions By Other, Electrical Requirements on page 44
May 29, 2017 - Added NOTE re: centerline to Figure 15 on page 17 and Figure 17 on page 19
August 22, 2017 - Added note re: bracket screws to Site Construction Details on page 6
March 27, 2018 - Revised speed spec on page 4 to say Nominal Speed
September 27, 2018 - Added ASME 18.1-2017 to code list on page 3
February 19, 2019 - Revised Site Construction Details and added a NOTE on page 7
February 28, 2020 - Revised 24V battery backup spec on page 6
February 29, 2020 - Added Savaria Link option to specs table on page 6 and provisions by others on page 46
May 6, 2020 - Added Load Calculations on pages 12 and 13
September 1, 2020 - Revised options in specs table on page 6

Specifications

V1504 Specifications

Specification	Specification Data
Load capacity	750 lb (340 kg)
Seat capacity	330 lb (150 kg)
Maximum travel	23 ft (7 m)
Nominal speed	20 ft/min (0.1 m/s)
Temperature	Indoor: +5 °F to +122 °F (-15 °C to +50 °C) Outdoor: -20 °F to +122 °F (-29 °C to +50 °C)
Noise level (for typical installation)	72.9 dBA (up direction); 50.0 dBA (down direction) Measured at a height of 1m, distance of 1m, in front of the motor with all panels on
Daily cycle	Normal: 30 Heavy: 75 Excessive: 100 Maximum starts in 1 hour on standard installation: 12 NOTE: Please consult your Sales Representative if there a chance you may exceed these amounts.
Levels serviced	2 (standard), 3, 4
Cab sizes	36" x 48" (914 mm x 1219 mm) 36" x 54" (914 mm x 1371 mm) 36" x 60" (914 mm x 1524 mm) 42" x 48" (1067 mm x 1219 mm) 42" x 54" (1067 mm x 1371 mm) 42" x 60" (1067 mm x 1524 mm)
Cab walls (height)	Standard 42-1/8" (1070 mm) Optional 80" (2031 mm)
Cab access	Enter/exit same side (platform Type 1L and 1R) Front/rear access (platform Type 2) 90 degree access (platform Type 3 and 4)
Power supply	120 VAC, 20 A, 60 Hz, single phase
Motor/drive	2:1 chain hydraulic, 3 Hp, gear-type motor (24 VDC)
Control system	Electronic-free relay logic controller
Distance between 2 landings	7" (178 mm) minimum
Tower	Modular 8 ft (2.4 m) base guide rail assembly Roller guide support
Pit depth requirement	3" (76.2 mm)
Finish	Beige electrostatic powder coat paint on all steel surfaces and vacuumed formed plastics
Standard features	24 VDC operation Call/send stations at landings Continuous-pressure type buttons Operating control buttons on platform Automatic battery recharging system (115 VAC) Remote manual lowering device Low-voltage controls Limit switches Handrail Non-skid platform surface No machine room required Emergency stop button

V1504 Specifications

Specification	Specification Data
Safety features	Platform gate Safety underpan Door locks Safety brake Emergency stop buttons Manual lowering and battery lowering system
Options	Platform gate with metal insert and electric strike Top landing gate Upper/lower landing door 80" (2032 mm) Fire-rated, flush-mounted landing entrances Folding seat on platform Telephone on platform Custom color Fixed access ramp Public building package Outdoor package Automatic safety ramp on platform (for outdoor model) 24V battery backup (minimum 5 trips, up and down) Remote controller/pump box Savaria Link remote monitoring Wooden door Doors or gate with glass or acrylic inserts

Site Construction Details

The V1504 needs a wall that supports a minimum of 472 lb (2100 N) of pull out force at each bolt of the bracket (two bolts per bracket). Note that the brackets come with the proper hardware to secure them in place (1/2" x 3" lag screws for wood/drywall or 1/2" x 4-1/4" anchor wedge screws for concrete walls). The floor must be capable of supporting a load of 3200 lb (14.2 kN). See Figure 1. A wall with a combination of two columns of three 2x4's, or a concrete or brick wall is required.

Figure 2 details a sample wooden support wall configuration

Figure 1: Wall/Floor Loading

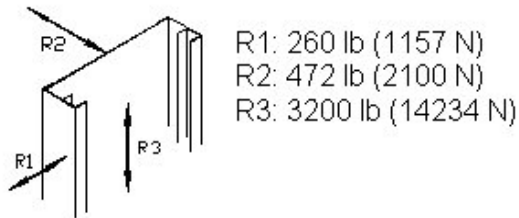

NOTE: For **R2**, 472 lb is at each bolt of the bracket (two bolts per bracket). Note that 472 lb is the Dead Load plus the Live Load at Allowable Stress Design levels. The Structural Engineer of Record must calculate the site-specific Seismic Load and Wind Load.

Figure 2: Sample Wooden Support Wall Configuration

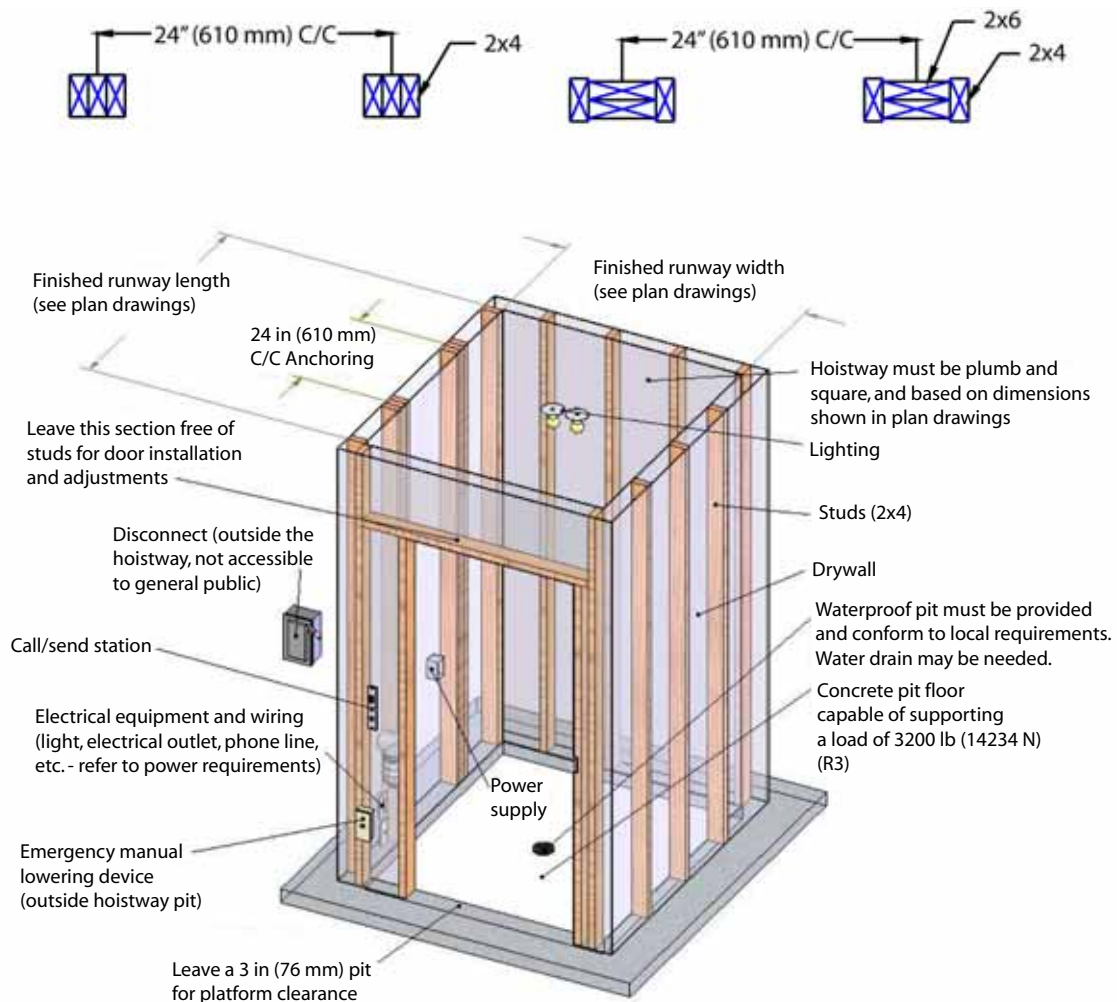

Figure 3 illustrates the recommended steps for constructing a wooden hoistway.

Figure 3: Wooden Hoistway Construction - Recommended Steps

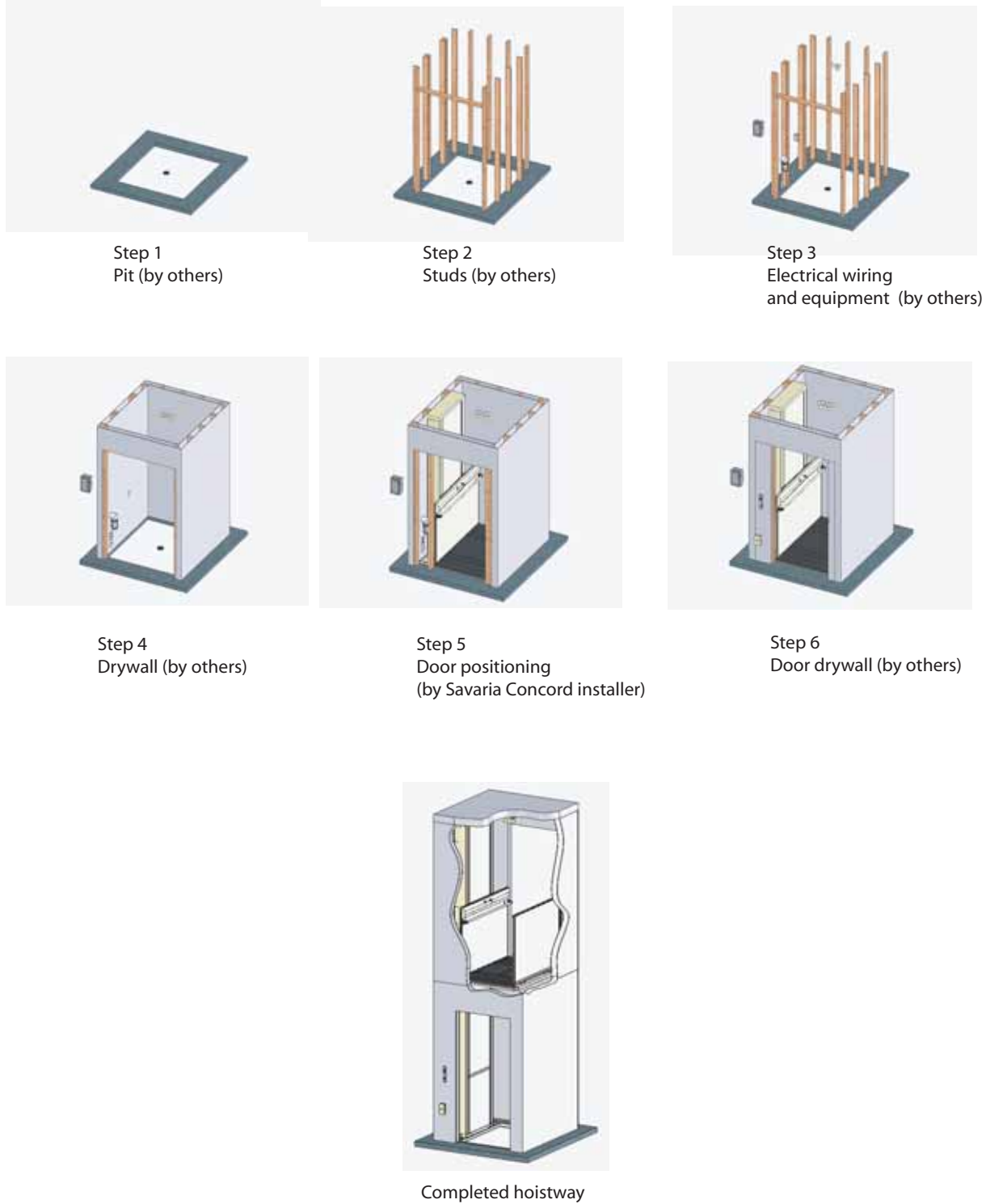

Figure 4 illustrates a sample concrete/steel structure configuration.

Figure 4: Sample Concrete/Steel Structure Configuration

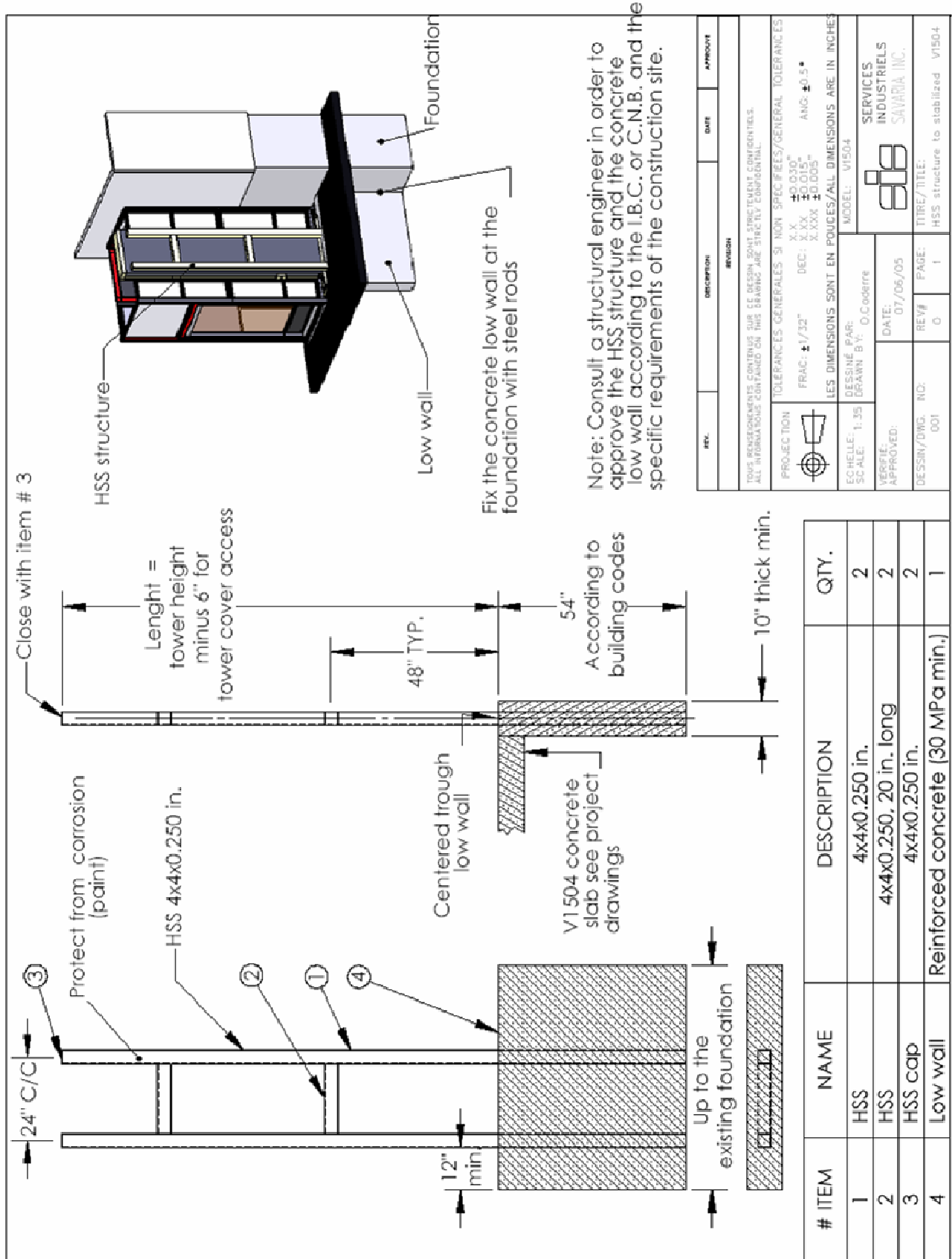

Figure 5 illustrates a sample outdoor enclosure application.

Figure 5: Sample Outdoor Enclosure Application

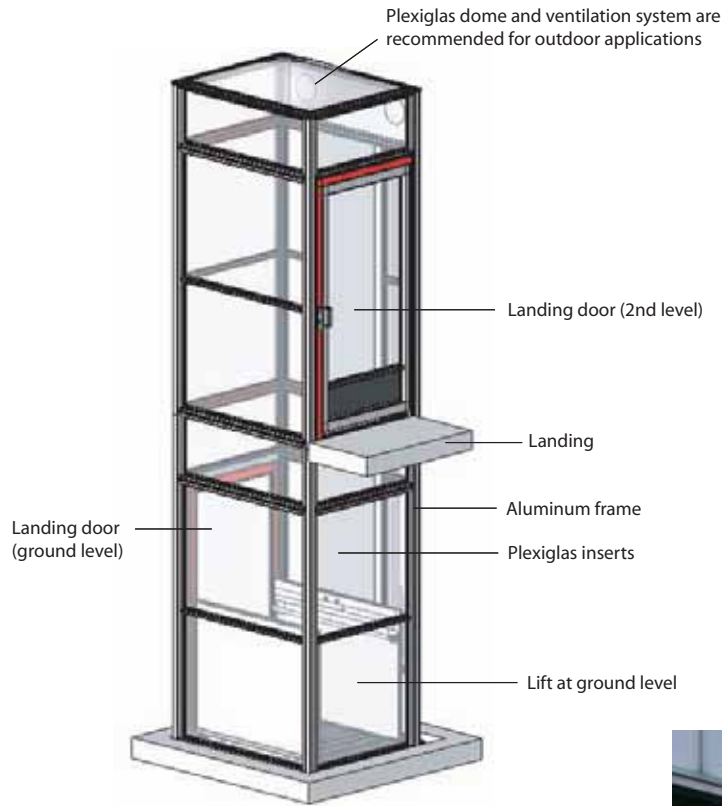

Figure 6 illustrates the site construction details for a typical outdoor application.

Figure 6: Sample Unenclosed Outdoor Application

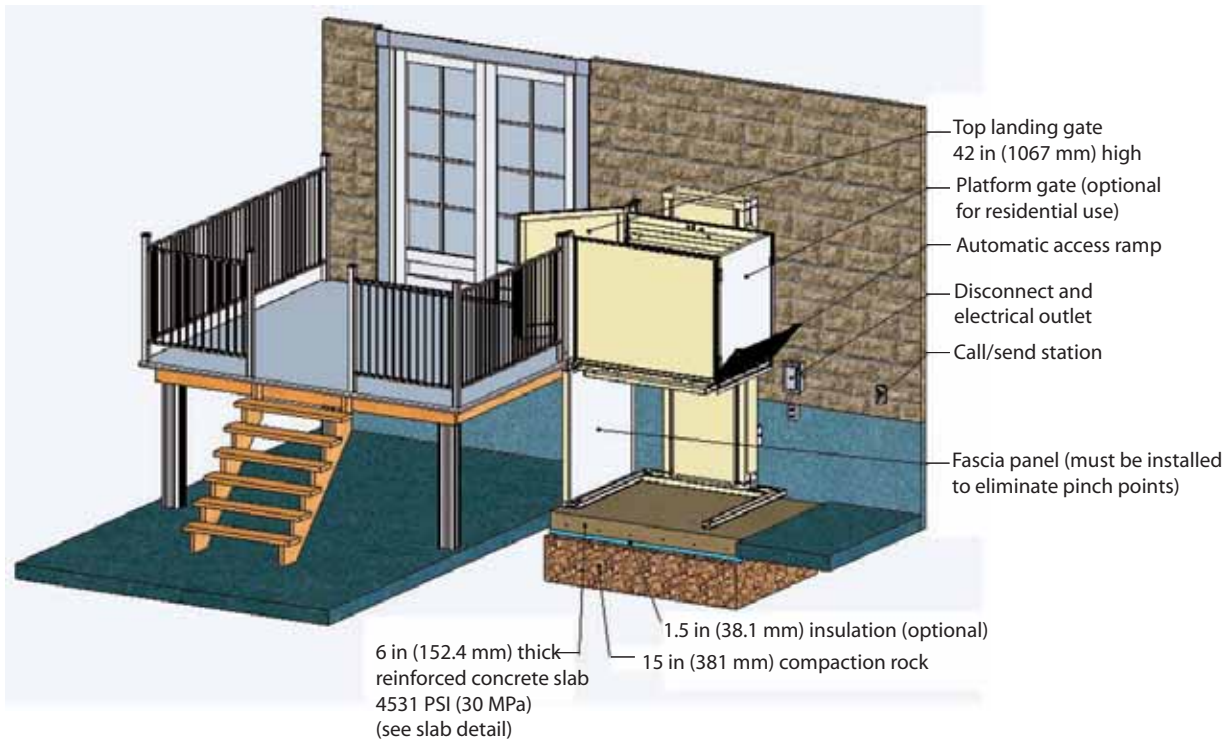
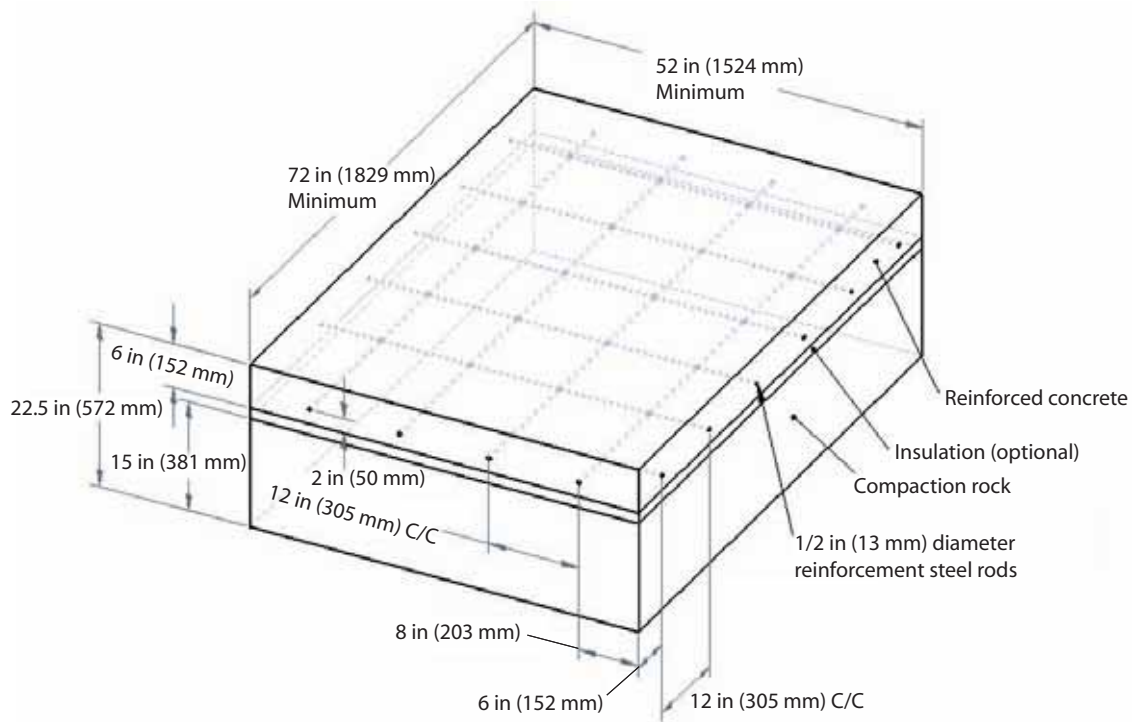

Figure 7 illustrates the concrete slab detail for a typical outdoor application.

Figure 7: Concrete Slab Detail



Load Calculations (V-1504)

SAVARIA V1504								
Vertical Platform Lift Anchoring Loads (worst case scenario)								
42x60" Platform, Hydraulic Drive, Hoistway Application					For Bracket Spacing of 36"		No Safety Factor	
Lift Model (inches)	MAX Tower Weight T (lbs)	-	MAX Car Weight CAR (lbs)	MAX Capacity CAP (lbs)	Support Height every 36" after base Last position H in inches	MAX Wall Support Loads per mounting points (double the values = per bracket) R2 (lbs)	Pit Load *if no support legs P (lbs)	Estimated Impact Load R3 (lbs)
48	500		500	750	92	472	1750	3200
60	550		500	750	102	472	1800	3200
72	625		500	750	124	472	1875	3200
96	725		500	750	138	472	1975	3200
108	800		500	750	160	472	2050	3200
120	875		500	750	172	472	2125	3200
144	1000		500	750	196	472	2250	3200
168	1025		500	750	218	472	2275	3200
192	1250		500	750	242	472	2500	3200
216	1350		500	750	266	472	2600	3200
240	1475		500	750	290	472	2725	3200
264	1575		500	750	312	472	2825	3200
276	1625		500	750	326	472	2875	3200

N.B.

Calculations do not include forces due to wind, seismic loading, any environmental loading and forces due to acceleration.

Calculations are assuming that the load is supported only by the 2 brackets surrounding the lift (worst case scenario).

A minimum Safety Factor of 4 is recommended; check local code requirements or the building special requirements.

The average standard cab weight is 350 lbs; the values vary accordingly.

If the building doesn't allow bracket mounting spacing of 36", R2 needs to be increased accordingly.

The Impact Load is not "necessary" if the lift is installed properly and maintained according to the manufacturer's recommendation

If the unit is ordered with base legs, the Pit Load related to cab weight and capacity will be spread on the footprint.

Vertical Platform Lift Anchoring Loads (worst case scenario)								
42x60" Platform, Hydraulic Drive, Enclosure Application					For Bracket Spacing of 36"		No Safety Factor	
Lift Model (inches)	MAX Tower Weight T (lbs)	MAX Enclosure Weight T (lbs)	MAX Car Weight CAR (lbs)	MAX Capacity CAP (lbs)	Support Height every 36" after base Last position H in inches	MAX Wall Support Loads per mounting points (double the values = per bracket) R2 (lbs)	Pit Load *if no support legs P (lbs)	Estimated Impact Load R3 (lbs)
48	500	625	500	750	92	472	2375	3200
60	550	675	500	750	102	472	2475	3200
72	625	725	500	750	124	472	2600	3200
96	725	825	500	750	138	472	2800	3200
108	800	875	500	750	160	472	2925	3200
120	875	925	500	750	172	472	3050	3200
144	1000	1025	500	750	196	472	3275	3200
168	1025	1125	500	750	218	472	3400	3200
192	1250	1225	500	750	242	472	3725	3200
216	1350	1325	500	750	266	472	3925	3200
240	1475	1425	500	750	290	472	4150	3200
264	1575	1525	500	750	312	472	4350	3200
276	1625	1625	500	750	326	472	4500	3200

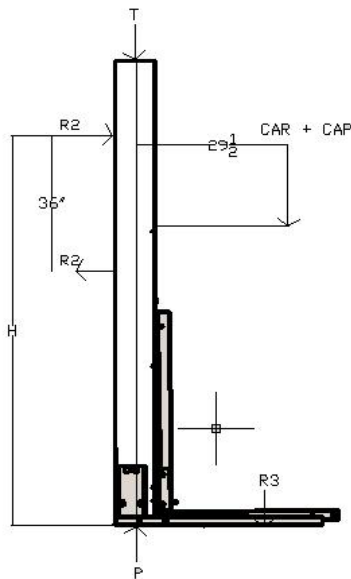

Load Calculations (V-1504 Prestige)

SAVARIA V1504 Prestige								
Vertical Platform Lift Anchoring Loads (worst case scenario)								
42x60" Platform, Hydraulic Drive, Enclosure Application					For Bracket Spacing of 36"		No Safety Factor	
Lift Model (inches)	MAX Tower Weight T (lbs)	Prestige Weight T (lbs)	MAX Car Weight CAR (lbs)	MAX Capacity CAP (lbs)	Support Height every 36" after base Last position H in inches	MAX Wall Support Loads per mounting points (double the values = per bracket) R2 (lbs)	Pit Load *if no support legs P (lbs)	Estimated Impact Load R3 (lbs)
48	500	1875	500	750	92	472	3625	3200
60	550	2025	500	750	102	472	3825	3200
72	625	2175	500	750	124	472	4050	3200
96	725	2475	500	750	138	472	4450	3200
108	800	2625	500	750	160	472	4675	3200
120	875	2775	500	750	172	472	4900	3200
144	1000	3075	500	750	196	472	5325	3200
168	1025	3375	500	750	218	472	5650	3200
192	1250	3675	500	750	242	472	6175	3200
216	1350	3975	500	750	266	472	6575	3200
240	1475	4275	500	750	290	472	7000	3200
264	1575	4575	500	750	312	472	7400	3200
276	1625	4875	500	750	326	472	7750	3200

N.B.

Calculations do not include forces due to wind, seismic loading, any environmental loading and forces due to acceleration.

Calculations are assuming that the load is supported only by the 2 brackets surrounding the lift (worst case scenario).

A minimum Safety Factor of 4 is recommended; check local code requirements or building special requirements.

The average standard cab weight is 350 lbs; the values vary accordingly.

If the building doesn't allow bracket mounting spacing of 36", R2 needs to be increased accordingly.

The Impact Load is not "necessary" if the lift is installed properly and maintained according to the manufacturer's recommendations

If the unit is ordered with base legs, the Pit Load related to cab weight and capacity will be spread on the footprint.

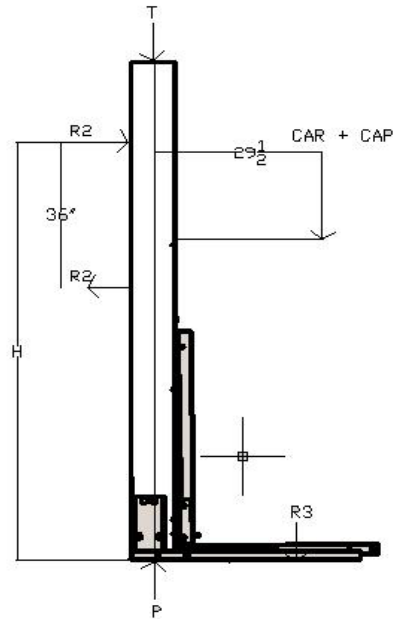

Cab Types

Type 1 Cabs

For type 1 cabs, entry and exit are available from only one end of the platform.

Figure 8: Type 1 Left and Right

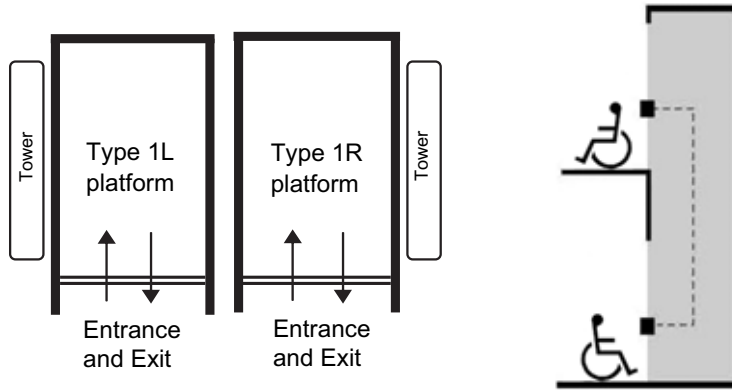

Type 2 Cabs

For type 2 cabs, entry and exit are available from both ends of the platform.

Figure 9: Type 2

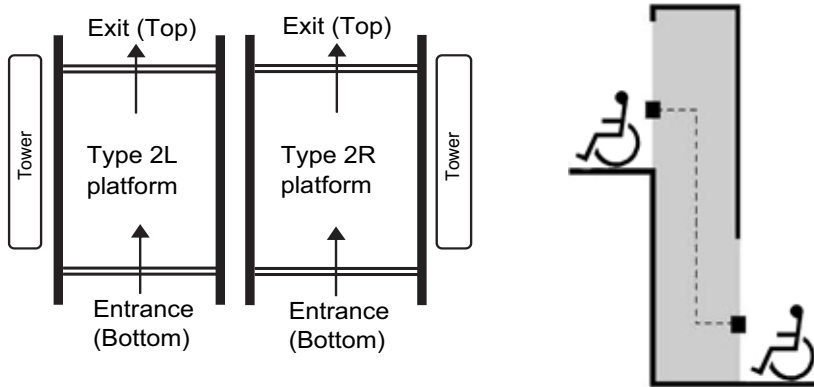

Type 3 and 4 Cabs

For type 3 and 4 cabs, entry and exit are available from one end and one side of the platform.

Figure 10: Type 3 and 4

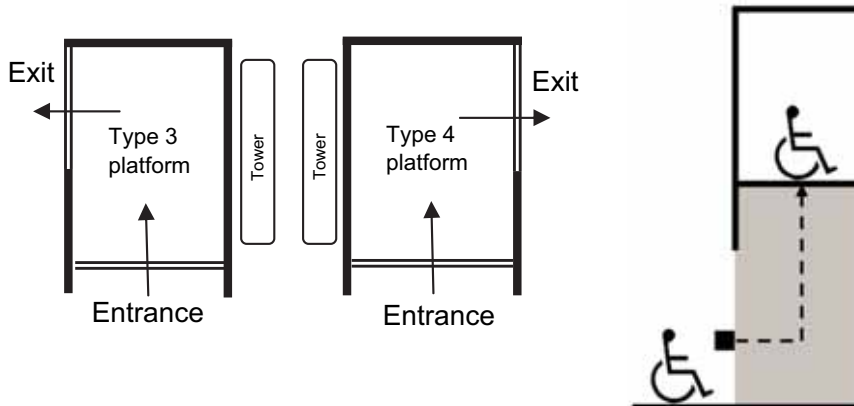

Drawings

- Elevation and plan view, hoistway application (Type 1L)
- Elevation and plan view, hoistway application (Type 1R)
- Elevation and plan view, hoistway application (Type 2)
- Elevation and plan view, hoistway application (Type 3)
- Elevation and plan view, hoistway application (Type 3, 45" opening)
- Elevation and plan view, hoistway application (Type 4)
- Elevation and plan view, hoistway application (Type 4, 45" opening)
- Elevation and plan view, enclosure application (Type 1L)
- Elevation and plan view, enclosure application (Type 1R)
- Elevation and plan view, enclosure application (Type 2)
- Elevation and plan view, enclosure application (Type 3, 45" opening)
- Elevation and plan view, enclosure application (Type 4, 45" opening)
- Auto door, left-hand
- Auto door, right-hand
- Manual door, left-hand
- Manual door, right-hand
- Prodoor auto, left-hand
- Prodoor auto, right-hand
- Prodoor manual, left-hand
- Prodoor manual, right-hand
- Prodoor installation (drywall)
- Auto half gate, left-hand
- Auto half gate, right-hand
- Manual half gate, left-hand
- Manual half gate, right-hand
- DuraSwing on half gate, right-hand
- DuraSwing on half gate, right-hand, 45" opening
- DuraSwing on half gate, left-hand
- DuraSwing on half gate, left-hand, 45" opening
- Seat dimensions
- Remote controller/pump box dimensions

Note: Refer to the Architects & Builders portion of our main website (www.savaria.com) for other door/gate sizes.

Figure 11: Elevation and plan view, hoistway application (Type 1L)

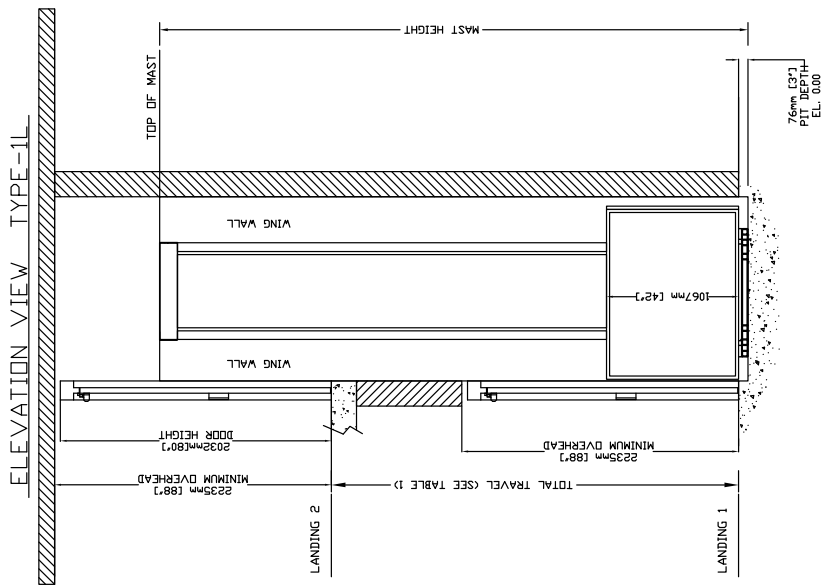

TABLE 1- MAST HEIGHT*

Max. Travel mm (Inches)	Extension Height mm (Inches)		Mast Height with 4.188\"/>	
	2388 (94\"/>			

*EXAMPLE TABLE WITH 3' PIT. DIMENSIONS VARY WITH TRAVEL

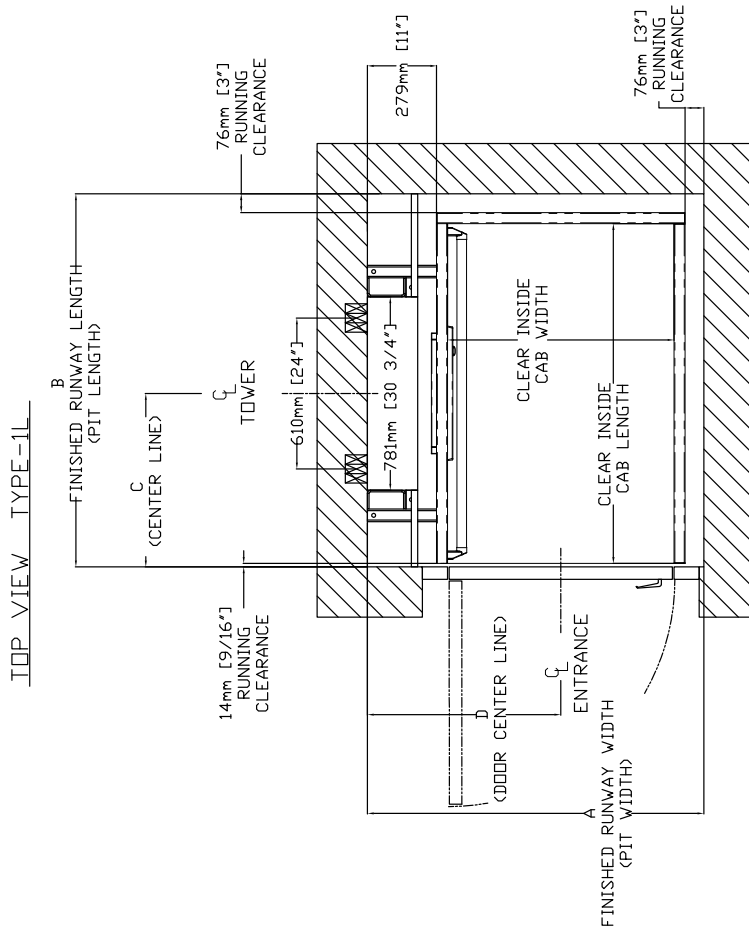

TABLE 2- HOISTWAY DIMENSION

CLEAR INSIDE CAB WIDTH	CLEAR INSIDE CAB LENGTH		FINISHED RUNWAY WIDTH		FINISHED RUNWAY LENGTH		TOWER CENTER LINE		DOOR CENTER LINE (IN CASE OF 36\"/>	
	mm	Inches	mm	Inches	mm	Inches	mm	Inches	mm	Inches

Figure 12: Elevation and plan view, hoistway application (Type 1R)

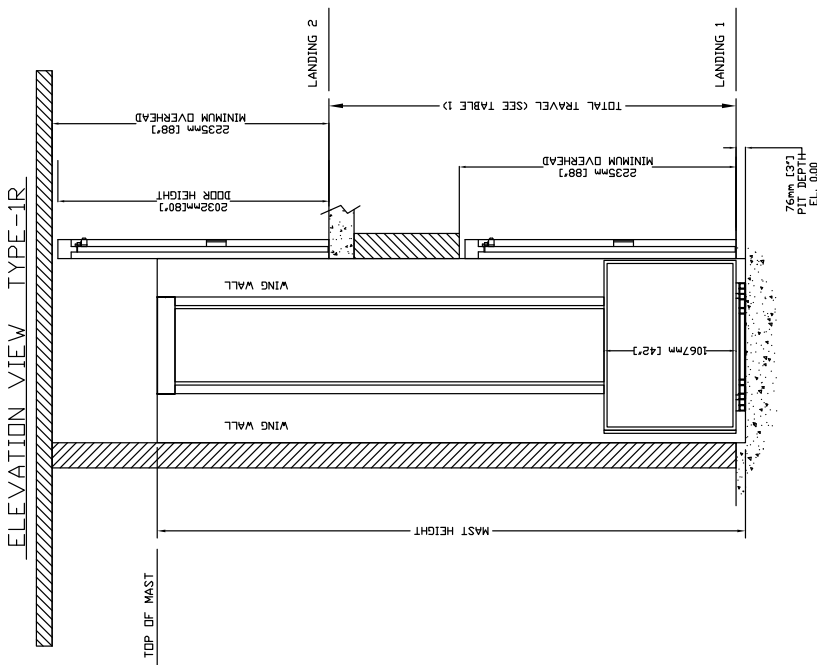

TABLE 1- MAST HEIGHT*

Max. Travel mm (Inches)	Extension Height mm (Inches)	Mast Height with 4.188" CAP mm (Inches)
1219 (48")	2388 (94")	1778 (70")
1524 (60")	1168 (46")	559 (22")
1829 (72")	1168 (46")	559 (22")
2438 (96")	1168 (46")	559 (22")
2743 (108")	1168 (46")	559 (22")
3048 (120")	1168 (46")	559 (22")
3658 (144")	1168 (46")	559 (22")
4267 (168")	1168 (46")	559 (22")
4877 (192")	1168 (46")	559 (22")
5486 (216")	1168 (46")	559 (22")
6096 (240")	1168 (46")	559 (22")
6706 (264")	1168 (46")	559 (22")
7010 (276")	1168 (46")	559 (22")

*EXAMPLE TABLE WITH 3" PIT, DIMENSIONS VARY WITH TRAVEL

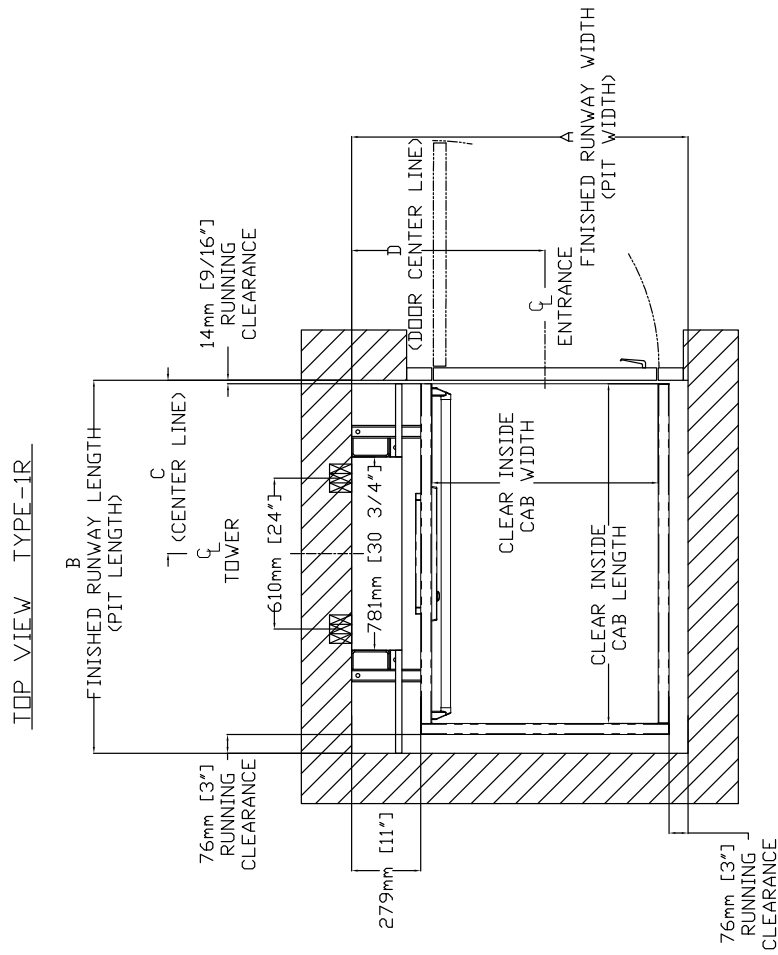

TABLE 2- HOISTWAY DIMENSION

CLEAR INSIDE CAB WIDTH mm (Inches)	CLEAR INSIDE CAB LENGTH mm (Inches)	A		B		C		D	
		FINISHED RUNWAY WIDTH mm (Inches)	FINISHED RUNWAY LENGTH mm (Inches)	FINISHED RUNWAY WIDTH mm (Inches)	FINISHED RUNWAY LENGTH mm (Inches)	TOWER CENTER LINE mm (Inches)	DOOR CENTER LINE (IN CASE OF 38" DOOR) mm (Inches)		
914	1219	48	1359	53 1/2	1354	624	24 9/16	781	30 3/4
914	1372	54	1507	53 1/2	1507	700	27 9/16	781	30 3/4
914	1524	60	1659	53 1/2	1659	776	30 9/16	781	30 3/4
1067	1219	48	1354	53 1/2	1354	624	24 9/16	857	33 3/4
1067	1372	54	1511	59 1/2	1507	700	27 9/16	857	33 3/4
1067	1524	60	1669	59 1/2	1669	776	30 9/16	857	33 3/4

Figure 13: Elevation and plan view, hoistway application (Type 2)

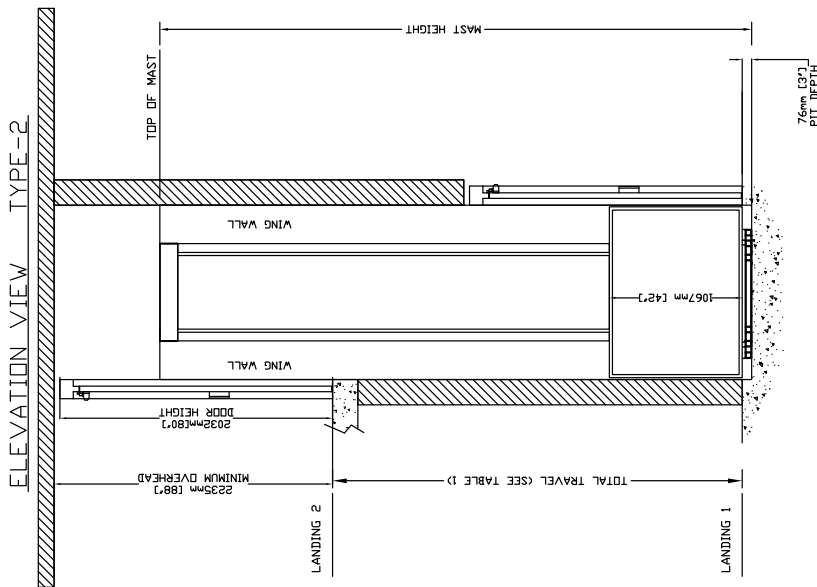

TABLE 1- MAST HEIGHT*

Max. Travel mm (Inches)	Extension Height mm (Inches)	Mast Height with 4,188" CAP mm (Inches)
1219 (48")	1	2748 (108.188)
1524 (60")	1	3053 (120.188)
1829 (72")	1	3307 (130.188)
2438 (96")	1	3916 (154.188)
2743 (108")	1	4272 (168.188)
3048 (120")	1	4526 (178.188)
3658 (144")	2	5136 (202.188)
4877 (192")	2	6050 (238.188)
5486 (216")	3	7269 (286.188)
6096 (240")	3	7828 (308.188)
6706 (264")	3	8438 (332.188)
7010 (276")	3	8692 (342.188)

*EXAMPLE TABLE WITH 3' PIT, DIMENSIONS VARY WITH TRAVEL

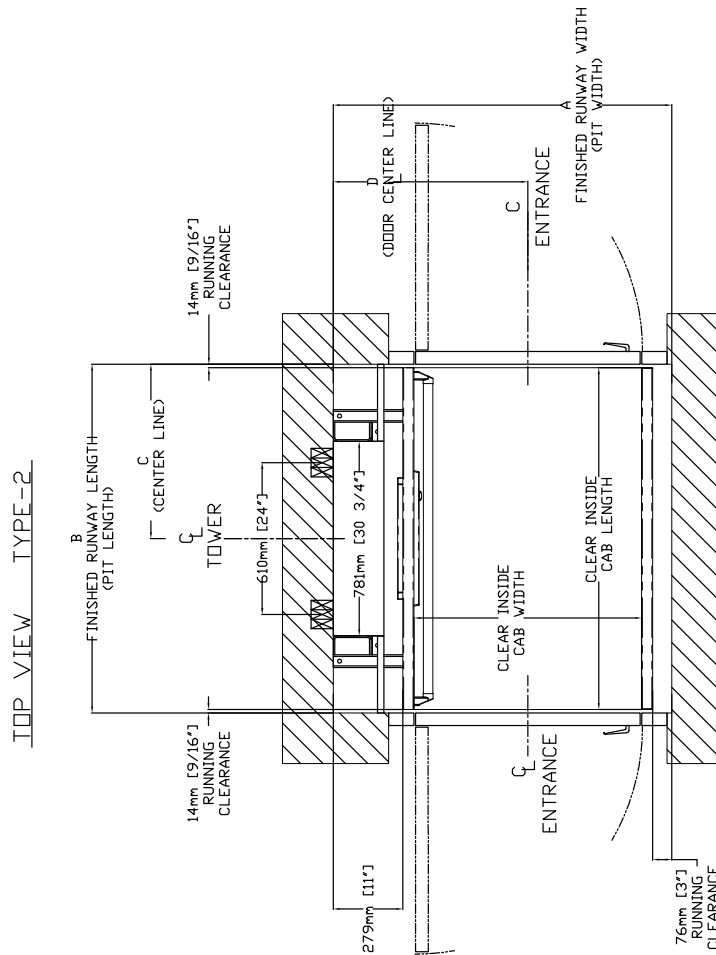

TABLE 2- HOISTWAY DIMENSION

CLEAR INSIDE CAB WIDTH mm	A		B		C		DOOR CENTER LINE (IN CASE OF 36" DOOR) Inches
	FINISHED RUNWAY WIDTH mm	Inches	FINISHED RUNWAY LENGTH mm	Inches	TOWER CENTER LINE mm	Inches	
914	1359	53 1/2	1248	49 1/8	624	24 9/16	30 3/4
914	1359	53 1/2	1400	55 1/8	700	27 9/16	30 3/4
914	1511	59 1/2	1553	61 1/8	776	30 9/16	30 3/4
1067	1511	59 1/2	1248	49 1/8	624	24 9/16	33 3/4
1067	1511	59 1/2	1400	55 1/8	700	27 9/16	33 3/4
1067	1511	59 1/2	1553	61 1/8	776	30 9/16	33 3/4

Figure 14: Elevation and plan view, hoistway application (Type 3)

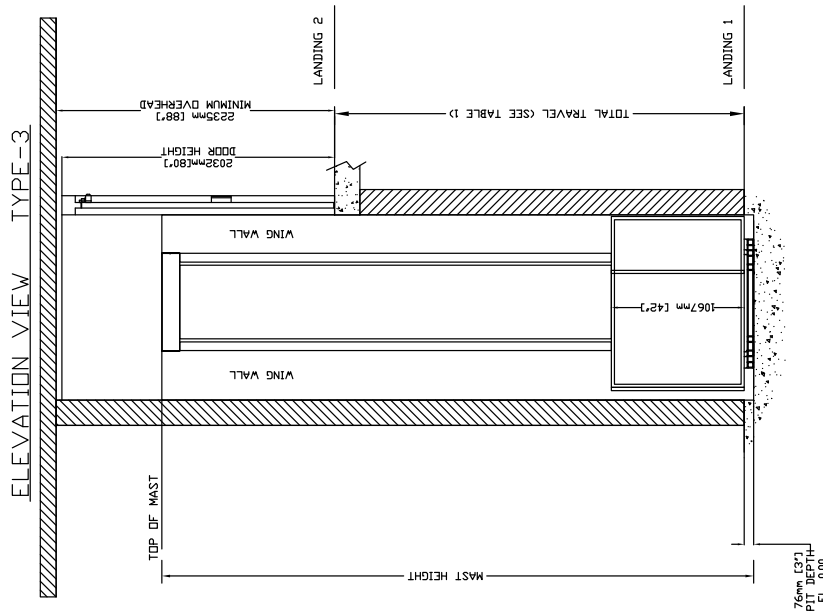

TABLE 1- MAST HEIGHT *

Max. Travel mm (Inches)	Extension Height mm (Inches)	Mast Height with 4,188" CAP mm (Inches)
2388 (94")	1778 (70")	1168 (46")
1219 (48")	1	254 (10")
1524 (60")	1	2748 (108.188)
1829 (72")	1	3053 (120.188)
2438 (96")	1	3307 (130.188)
2743 (108")	1	3916 (154.188)
3048 (120")	1	4272 (168.188)
3658 (144")	2	4526 (178.188)
4267 (168")	2	5136 (202.188)
4877 (192")	2	6050 (238.188)
5486 (216")	3	6660 (262.188)
6096 (240")	3	7269 (286.188)
6706 (264")	3	7828 (308.188)
7010 (276")	3	8438 (332.188)
		8692 (342.188)

*EXAMPLE TABLE WITH 3" PIT, DIMENSIONS VARY WITH TRAVEL

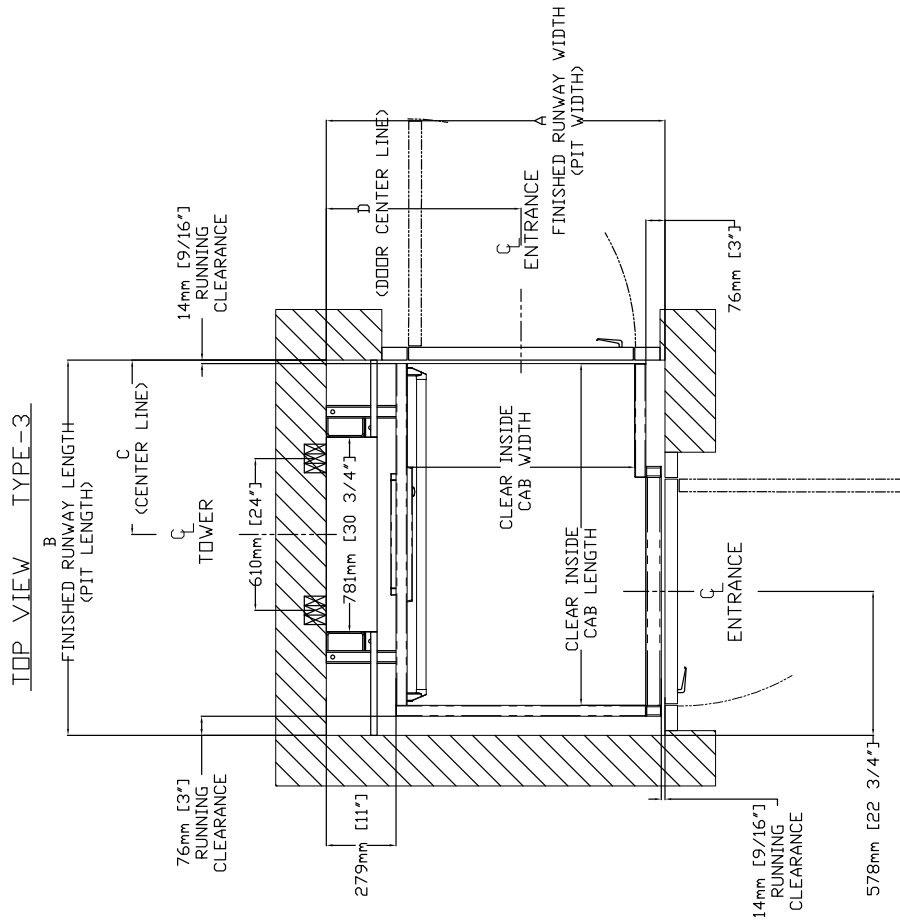

TABLE 2- HOISTWAY DIMENSION

CLEAR INSIDE CAB WIDTH	CLEAR INSIDE CAB LENGTH		FINISHED RUNWAY WIDTH		FINISHED RUNWAY LENGTH		TOWER CENTER LINE	DOOR CENTER LINE (IN CASE OF 36" DOOR)	
	mm	Inches	mm	Inches	mm	Inches			
914	36	1219	48	1359	53 1/2	1354	24	9/16	30 3/4
914	36	1372	54	1359	53 1/2	1507	59	5/16	30 3/4
914	36	1524	60	1359	53 1/2	1659	65	5/16	30 3/4
1067	42	1219	48	1511	59 1/2	1354	53	5/16	33 3/4
1067	42	1372	54	1511	59 1/2	1507	59	5/16	33 3/4
1067	42	1524	60	1511	59 1/2	1659	65	5/16	33 3/4

Figure 15: Elevation and plan view, hoistway application (Type 3, 45" opening)

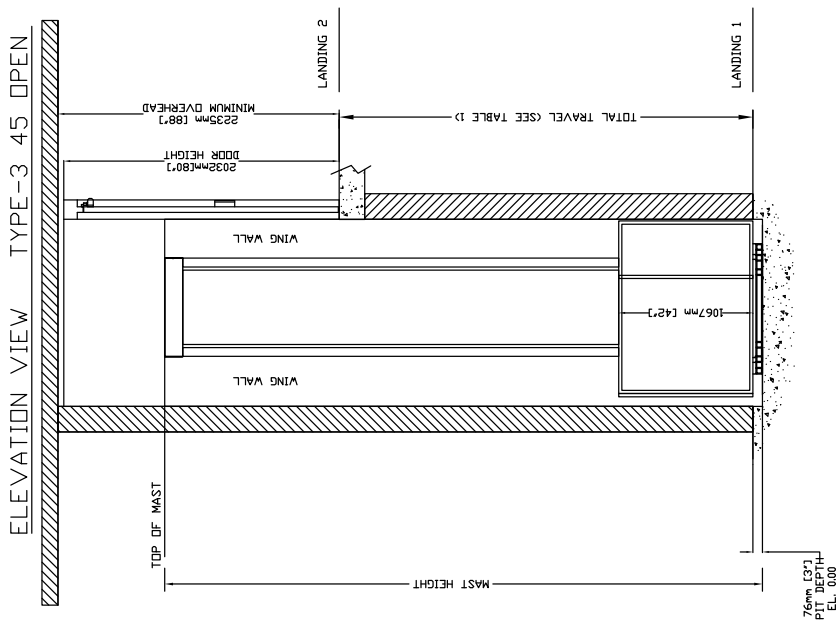

TABLE 1- MAST HEIGHT*

Max. Travel mm (Inches)	Extension Height mm (Inches)		Mast Height with 4.188" CAP mm (Inches)	
	2388 (94")	1778 (70")	1168 (46")	559 (22")
1219 (48")	1	1	2748	108.188
1524 (60")	1	1	3053	120.188
1829 (72")	1	1	3307	130.188
2438 (96")	1	1	3916	154.188
2743 (108")	1	1	4272	168.188
3048 (120")	1	1	4526	178.188
3658 (144")	2	1	5136	202.188
4267 (168")	2	1	6050	238.188
4877 (192")	2	1	6660	262.188
5486 (216")	3	1	7269	286.188
6096 (240")	3	1	7828	308.188
6706 (264")	3	1	8438	332.188
7010 (276")	3	1	8692	342.188

*EXAMPLE TABLE WITH 3" PIT. DIMENSIONS VARY WITH TRAVEL

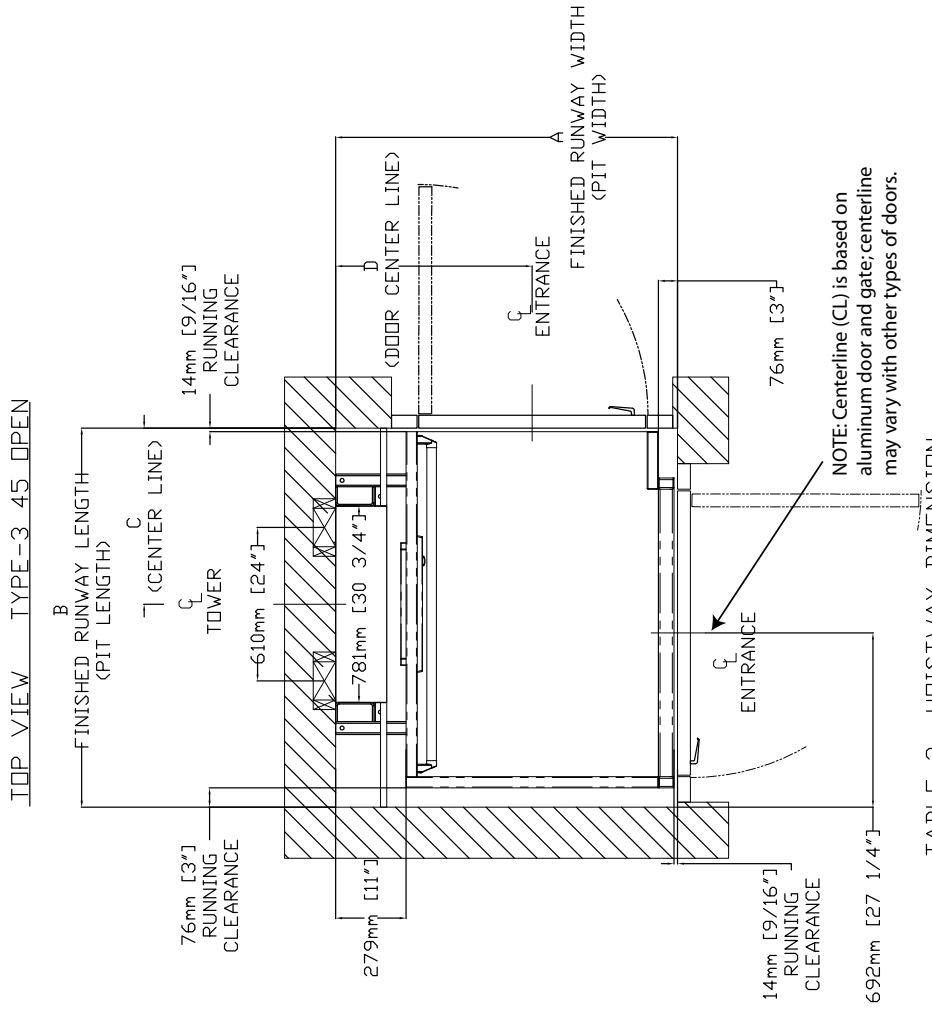

TABLE 2- HOISTWAY DIMENSION

CLEAR INSIDE CAB WIDTH	CLEAR INSIDE CAB LENGTH		FINISHED RUNWAY WIDTH		FINISHED RUNWAY LENGTH		TOWER CENTER LINE		DOOR CENTER LINE (IN CASE OF 36" DOOR)		
	mm	Inches	mm	Inches	mm	Inches	mm	Inches	mm	Inches	
914	36	1219	48	1359	53 1/2	1354	53 5/16	624	24 9/16	781	30 3/4
914	36	1372	54	1359	53 1/2	1507	59 5/16	700	27 9/16	781	30 3/4
914	36	1524	60	1359	53 1/2	1659	65 5/16	776	30 9/16	781	30 3/4
1087	42	1219	48	1511	59 1/2	1354	53 5/16	624	24 9/16	857	33 3/4
1087	42	1372	54	1511	59 1/2	1507	59 5/16	700	27 9/16	857	33 3/4
1087	42	1524	60	1511	59 1/2	1659	65 5/16	776	30 9/16	857	33 3/4

NOTE: Centerline (CL) is based on aluminum door and gate; centerline may vary with other types of doors.

Figure 16: Elevation and plan view, hoistway application (Type 4)

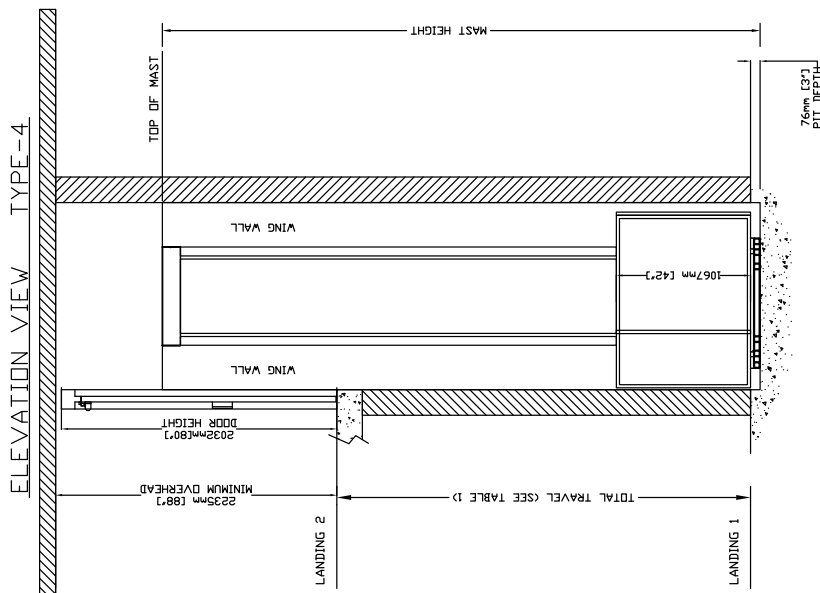

TABLE 1- MAST HEIGHT*

Max Travel mm (inches)	Extension Height mm (inches)		Mast Height with 4, 188" CAP mm (inches)
	1778 (70")	1168 (46")	
2388 (94")	1	1	254 (10")
1219 (48")	1	1	2748 108, 188
1524 (60")	1	1	3053 120, 188
1829 (72")	1	1	3307 130, 188
2438 (96")	1	1	3916 154, 188
2743 (108")	1	1	4272 168, 188
3048 (120")	1	1	4526 178, 188
3658 (144")	2	1	5136 202, 188
4267 (168")	2	1	6050 238, 188
4877 (192")	2	1	6660 262, 188
5486 (216")	3	1	7269 286, 188
6096 (240")	3	1	7828 308, 188
6706 (264")	3	1	8438 332, 188
7010 (276")	3	1	8692 342, 188

*EXAMPLE TABLE WITH 3" PIT. DIMENSIONS VARY WITH TRAVEL

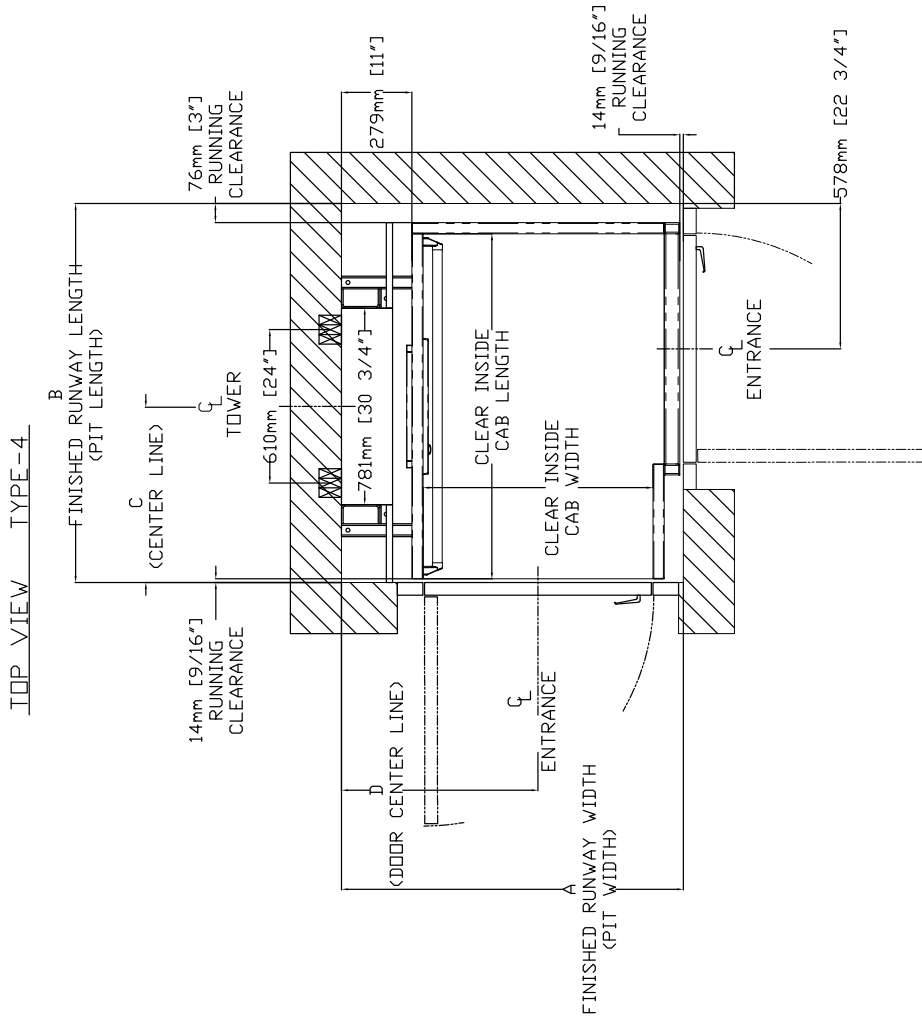

TABLE 2- HOISTWAY DIMENSION

CLEAR INSIDE CAB WIDTH	CLEAR INSIDE CAB LENGTH		FINISHED RUNWAY WIDTH		FINISHED RUNWAY LENGTH		TOWER CENTER LINE		DOOR CENTER LINE (IN CASE OF 48" DOOR)	
	mm	Inches	mm	Inches	mm	Inches	mm	Inches	mm	Inches
914	36	1219	48	1359	53 1/2	1354	624	24 9/16	781	30 3/4
914	36	1219	54	1359	59 1/2	1507	700	27 9/16	781	30 3/4
914	36	1524	60	1359	53 1/2	1659	776	30 9/16	857	33 3/4
1067	42	1219	48	1511	59 1/2	1354	624	24 9/16	857	33 3/4
1067	42	1372	54	1511	59 1/2	1507	700	27 9/16	857	33 3/4
1067	42	1524	60	1511	59 1/2	1659	776	30 9/16	857	33 3/4

Figure 17: Elevation and plan view, hoistway application (Type 4, 45" opening)

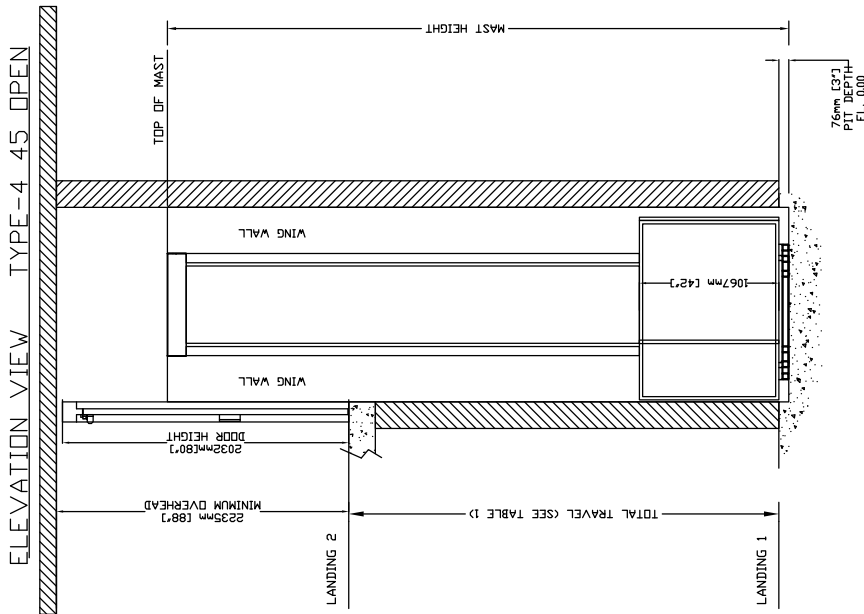

TABLE 1- MAST HEIGHT*

Max. Travel mm (Inches)	Extension Height mm (Inches)	Mast Height with 4.188" CAP mm (Inches)
1219 (48')	2388 (94')	1778 (70')
1524 (60')	1168 (46')	559 (22')
1829 (72')	1	254 (10')
2438 (96')	1	1
2743 (108')	1	1
3048 (120')	1	1
3658 (144')	2	1
4267 (168')	2	1
5486 (216')	3	1
6096 (240')	3	1
6706 (264')	3	1
7010 (276')	3	1

*EXAMPLE TABLE WITH 3" PIT, DIMENSIONS VARY WITH TRAVEL

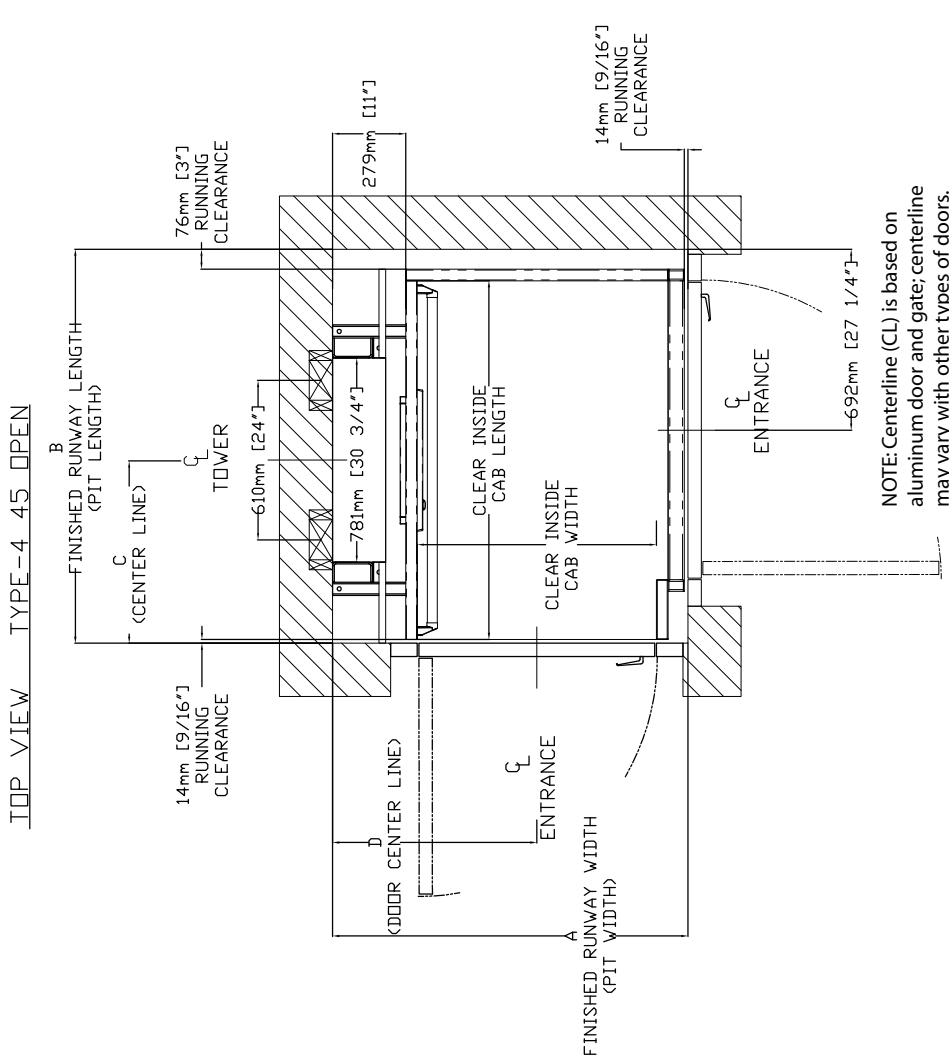

TABLE 2- HOISTWAY DIMENSION

CLEAR INSIDE CAB WIDTH		CLEAR INSIDE CAB LENGTH		FINISHED RUNWAY WIDTH		FINISHED RUNWAY LENGTH		TOWER CENTER LINE		DOOR CENTER LINE (IN CASE OF 36" DOOR)	
mm	Inches	mm	Inches	mm	Inches	mm	Inches	mm	Inches	mm	Inches
914	36	1219	48	1359	53 1/2	1354	53 5/16	624	24 9/16	781	30 3/4
914	36	1372	54	1359	53 1/2	1507	59 5/16	700	27 9/16	781	30 3/4
1067	42	1219	48	1511	59 1/2	1354	53 5/16	776	30 9/16	857	33 3/4
1067	42	1372	54	1511	59 1/2	1507	59 5/16	700	27 9/16	857	33 3/4
1067	42	1524	60	1511	59 1/2	1659	65 5/16	776	30 9/16	857	33 3/4

Figure 18: Elevation and plan view, enclosure application (Type 1L)

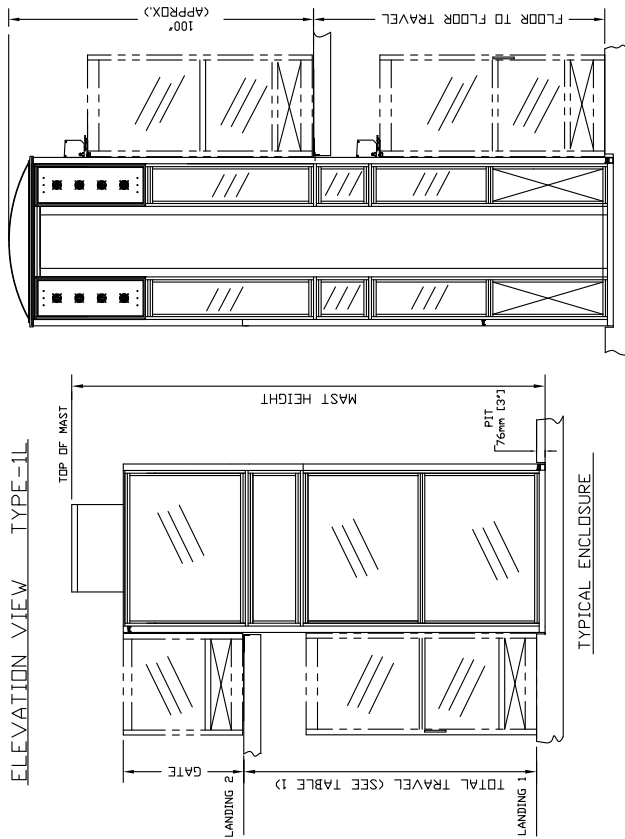
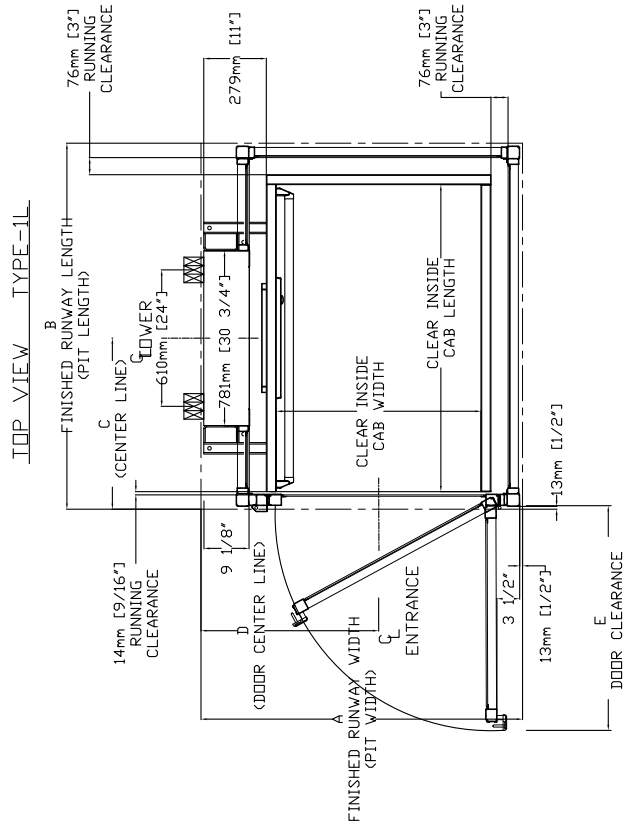

TABLE 1- MAST HEIGHT*

Max. Travel mm (Inches)	Extension Height mm (Inches)	Mast Height Approx with Gate with 4.188" CAP mm (Inches)
2388 (94")	1776 (70")	1168 (46")
1219 (48")	1	2748 (108.188)
1524 (60")	1	3053 (120.188)
1829 (72")	1	3662 (144.188)
2438 (96")	1	4272 (168.188)
2743 (108")	1	4272 (168.188)
3048 (120")	2	4882 (192.188)
3658 (144")	2	5490 (214.188)
4267 (168")	2	6050 (238.188)
4877 (192")	2	6660 (262.188)
5486 (216")	3	7269 (286.188)
6096 (240")	3	7828 (308.188)
6706 (264")	3	8438 (332.188)
7010 (276")	3	8692 (342.188)

*EXAMPLE TABLE WITH 3" PIT, DIMENSIONS VARY WITH TRAVEL

TABLE 2 - ENCLOSURE DIMENSION

CLEAR INSIDE CAB WIDTH		CLEAR INSIDE CAB LENGTH		A		B		C		D		E	
mm	Inches	mm	Inches	FINISHED RUNWAY WIDTH	FINISHED RUNWAY LENGTH	TOWER CENTER LINE	DOOR CENTER LINE (IN CASE OF 36" DOOR)	DOOR CENTER LINE	DOOR CLEARANCE	mm	Inches	mm	Inches
914	36	1219	48	1437	58.318	687	27.116	754	31.114	1100	43.516	1100	43.516
914	36	1372	54	1437	58.318	784	30.118	784	31.114	1100	43.516	1100	43.516
914	36	1525	60	1437	58.318	880	33.118	880	34.114	1100	43.516	1100	43.516
1067	42	1372	54	1589	62.916	784	30.118	870	34.114	1253	49.516	1253	49.516
1067	42	1524	60	1589	62.916	880	33.118	870	34.114	1253	49.516	1253	49.516

Figure 19: Elevation and plan view, enclosure application (Type 1R)

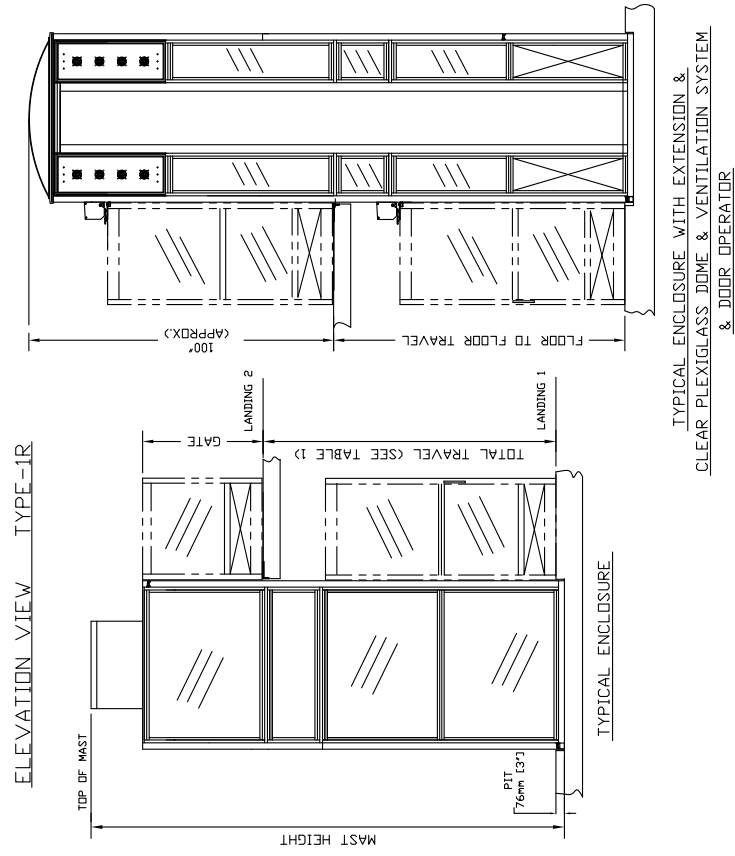
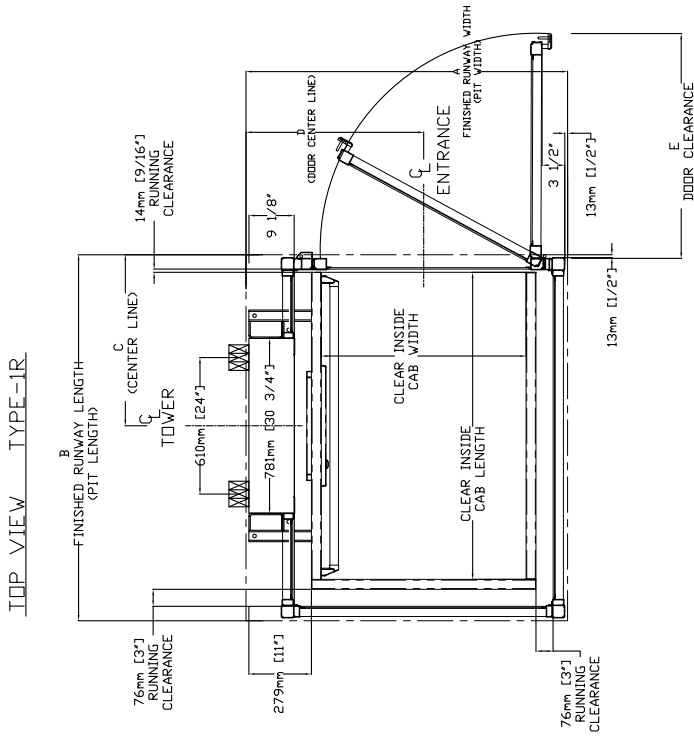

TABLE 1- MAST HEIGHT*

Max. Travel mm (Inches)	Extension Height mm (Inches)	Mast-Height Approx with Gate with 4.188" CAP
1219 (48")	2388 (94")	2748 (108.188)
1524 (60")	1	3053 (120.188)
1829 (72")	1	3662 (144.188)
2438 (96")	1	4272 (168.188)
2743 (108")	1	4272 (168.188)
3048 (120")	2	4882 (192.188)
3658 (144")	2	5440 (214.188)
4267 (168")	2	6050 (238.188)
4877 (192")	3	6660 (262.188)
5486 (216")	3	7269 (286.188)
6096 (240")	3	7828 (308.188)
6706 (264")	3	8438 (332.188)
7010 (276")	3	8692 (342.188)

*EXAMPLE TABLE WITH 3" PIT. DIMENSIONS VARY WITH TRAVEL

TABLE 2 - ENCLOSURE DIMENSION

CLEAR INSIDE CAB WIDTH	CLEAR INSIDE CAB LENGTH		FINISHED RUNWAY WIDTH		FINISHED RUNWAY LENGTH		TOWER CENTER LINE		DOOR CENTER LINE (IN CASE OF 36" DOOR)		DOOR CLEARANCE		
	mm	Inches	mm	Inches	mm	Inches	mm	Inches	mm	Inches	mm	Inches	
1687	46	1324	62	2.4	1168	76	3.0	640	25.2	910	34.1	1253	49.3
1007	42	1372	62	2.4	1035	84	3.3	704	27.7	870	34.1	1253	49.3
1097	42	1219	62	2.4	1483	58	2.3	657	25.9	870	34.1	1253	49.3
914	36	1524	58	2.3	1768	70	2.8	840	33.1	754	29.7	1100	43.3
84	3.3	1372	52	2.0	1636	64	2.5	794	31.3	754	29.7	1100	43.3
64	2.5	1437	56	2.2	1535	62	2.4	764	30.1	754	29.7	1100	43.3
54	2.1	1524	52	2.0	1636	64	2.5	794	31.3	754	29.7	1100	43.3
46	1.8	1589	62	2.4	1483	58	2.3	657	25.9	870	34.1	1253	49.3

Figure 20: Elevation and plan view, enclosure application (Type 2)

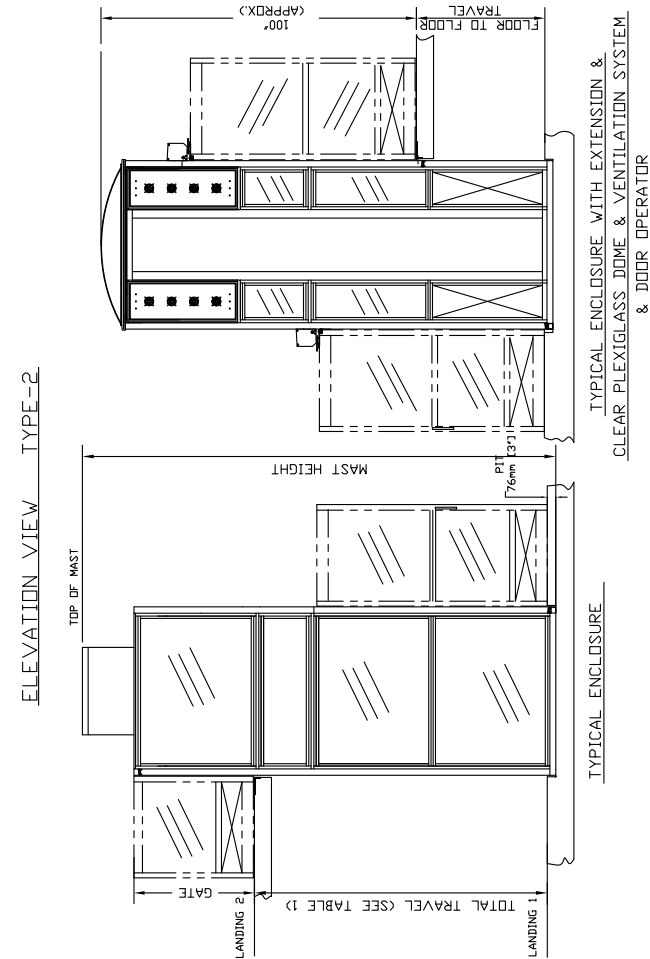
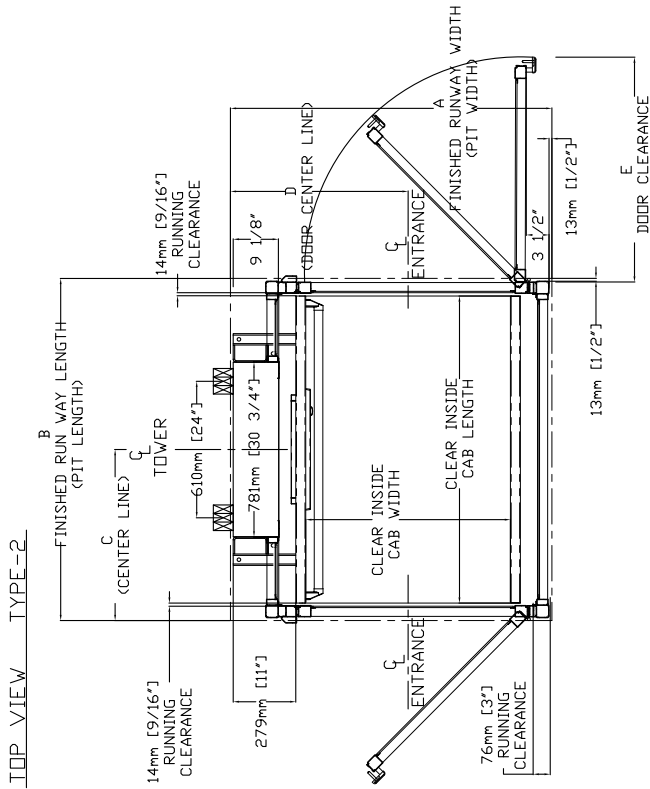

TABLE 1- MAST HEIGHT*

Max Travel mm (inches)	Extension Height mm (inches)	Mast Height Approx with Gate with 4, 188" CAP mm (inches)
2388 (94")	1778 (70")	1168 (46")
1219 (48")	1	254 (10")
1524 (60")	1	2748
1829 (72")	1	108,188
2438 (96")	1	3053
2743 (108")	1	120,188
3048 (120")	1	3662
3658 (144")	2	4272
4267 (168")	2	4882
4877 (192")	2	132,188
5486 (216")	3	192,188
6096 (240")	3	252,188
6706 (264")	3	312,188
7316 (288")	3	372,188

*EXAMPLE TABLE WITH 3" PIT. DIMENSIONS VARY WITH TRAVEL

TABLE 2 - ENCLOSURE DIMENSION

CLEAR INSIDE CAB WIDTH	CLEAR INSIDE CAB LENGTH		FINISHED RUNWAY WIDTH		FINISHED RUNWAY LENGTH		TOWER CENTER LINE		DOOR CENTER LINE (IN CASE OF 36" DOOR)		DOOR CLEARANCE					
	mm	Inches	mm	Inches	mm	Inches	mm	Inches	mm	Inches	mm	Inches				
914	36	1219	56	2 1/8	1376	54	3/16	687	27	11 1/8	794	31	1 1/4	1100	43	5/16
914	36	1372	54	2 1/8	1437	56	3/16	764	30	1 1/8	794	31	1/4	1100	43	5/16
914	36	1524	56	2 1/8	1599	62	3/16	841	33	1 1/8	871	34	1/4	1100	43	5/16
1067	42	1679	58	2 1/8	1761	64	3/16	918	36	1 3/8	948	37	1/4	1253	49	5/16
1067	42	1832	60	2 3/8	1923	66	3/16	995	39	1 5/8	1025	40	1/4	1253	49	5/16
1067	42	1985	62	2 4/8	2085	68	3/16	1072	42	1 7/8	1102	43	1/4	1253	49	5/16

Figure 21: Elevation and plan view, enclosure application (Type 3, 45" opening)

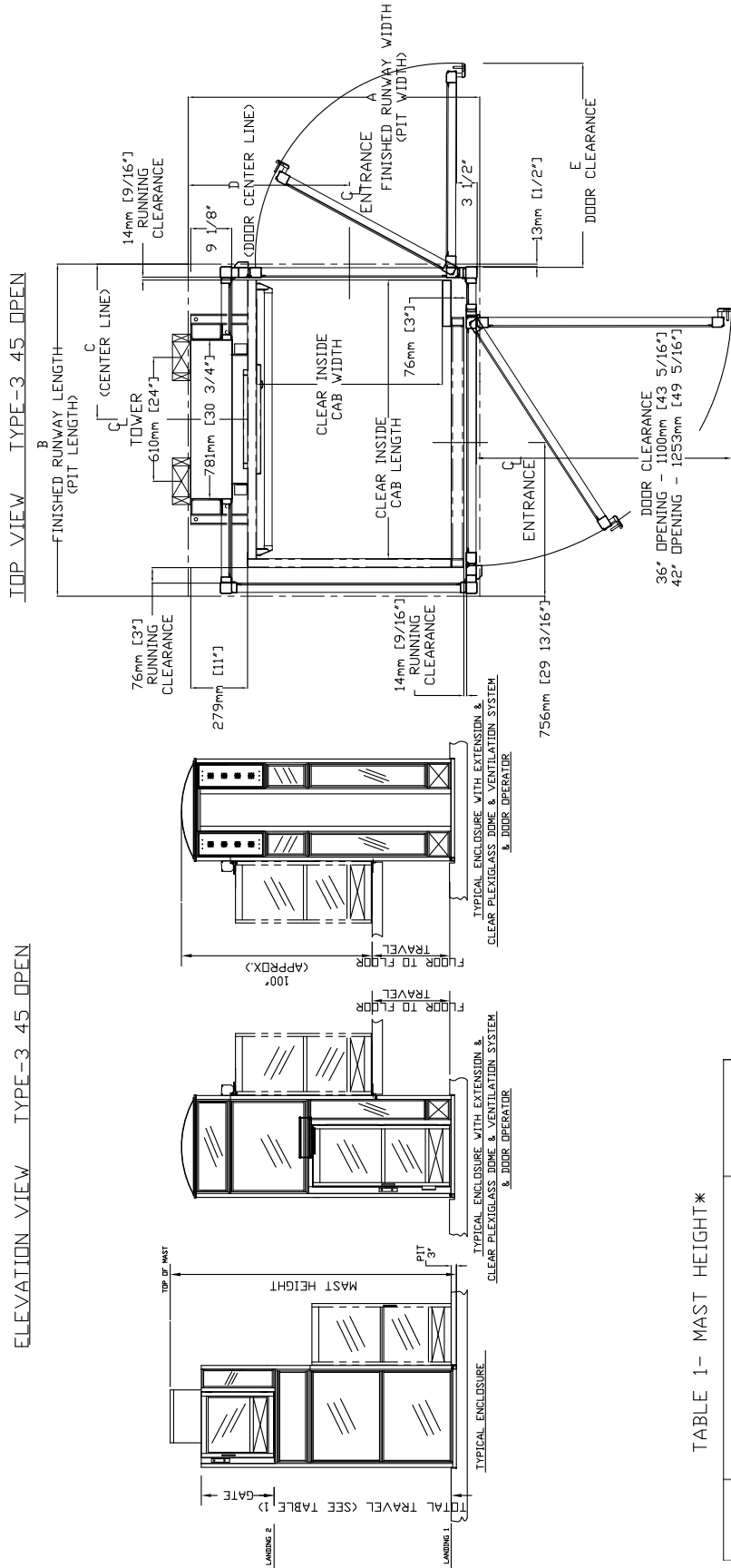

TABLE 1 - MAST HEIGHT *

Max Travel mm (Inches)	Extension Height mm (Inches)		Mast Height Approx with Gate with 4.188" CAP
	2388 (94")	1778 (70")	
1219 (48")	1	1	2748 108.188
1524 (60")	1	1	3053 120.188
1829 (72")	1	1	3662 144.188
2438 (96")	1	1	4272 168.188
2743 (108")	1	1	4272 168.188
3048 (120")	2	1	4882 192.188
3658 (144")	2	1	5440 214.188
4267 (168")	2	1	6050 238.188
4877 (192")	2	1	6660 262.188
5486 (216")	3	1	7269 286.188
6096 (240")	3	1	7828 308.188
6706 (264")	3	1	8438 332.188
7010 (276")	3	1	8692 342.188

*EXAMPLE TABLE WITH 3" PIT. DIMENSIONS VARY WITH TRAVEL

TABLE 2 - ENCLOSURE DIMENSION

CLEAR INSIDE CAB WIDTH	A CLEAR INSIDE CAB LENGTH		B FINISHED RUNWAY WIDTH		C FINISHED RUNWAY LENGTH		D DOOR CENTER LINE (IN CASE OF 36" DOOR)		E DOOR CLEARANCE	
	mm	Inches	mm	Inches	mm	Inches	mm	Inches	mm	Inches
36	1219	48	1437	56 9/16	1483	58 3/8	887	34 9/16	754	29 11/16
54	1372	54	1437	56 9/16	1635	64 3/8	764	30 1/16	754	29 11/16
36	1219	48	1437	56 9/16	1483	58 3/8	887	34 9/16	754	29 11/16
54	1372	54	1437	56 9/16	1635	64 3/8	764	30 1/16	754	29 11/16
42	1372	54	1589	62 5/16	1635	64 3/8	764	30 1/16	870	34 1/4
42	1372	54	1589	62 5/16	1788	70 3/8	840	33 1/16	870	34 1/4

Figure 22: Elevation and plan view, enclosure application (Type 4, 45" opening)

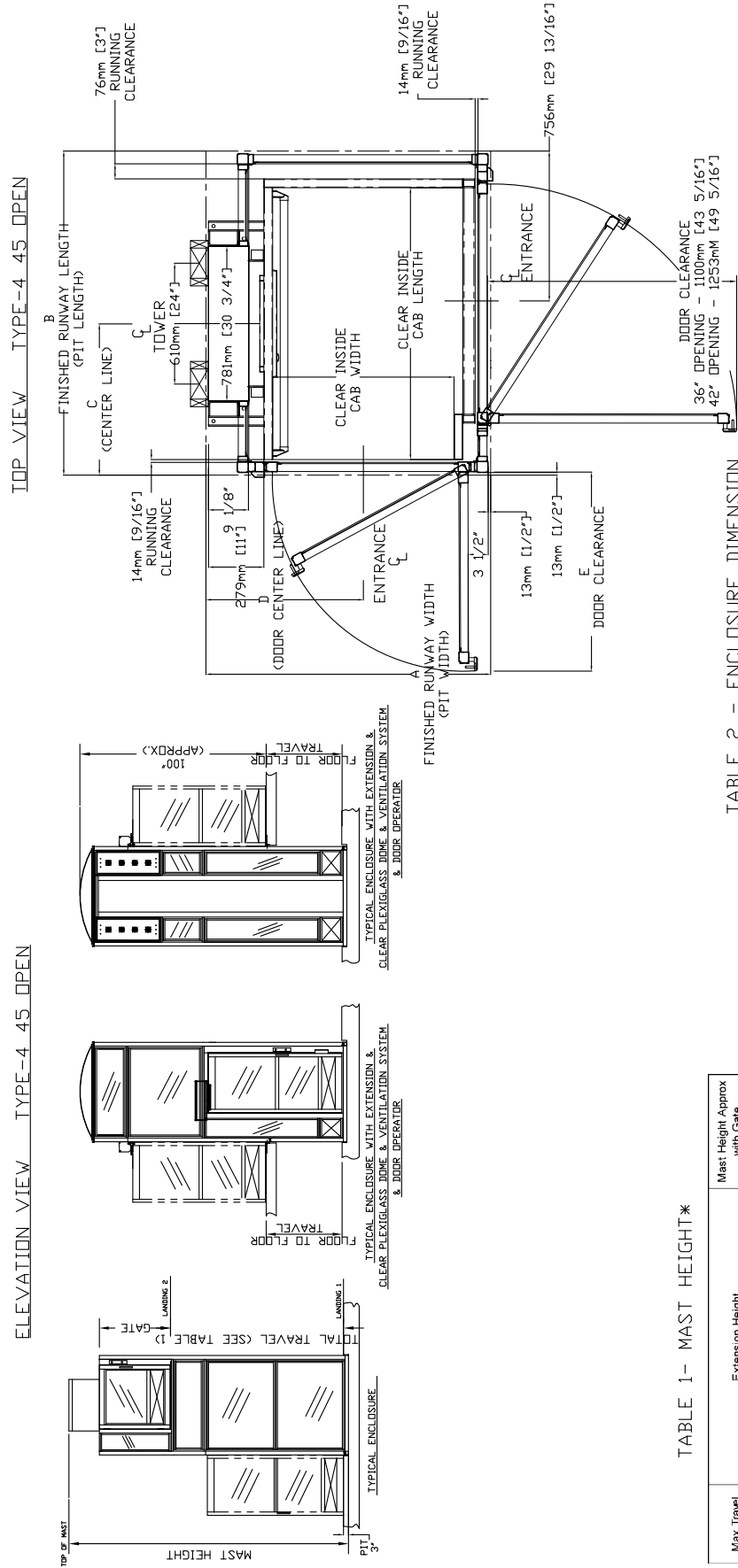

TABLE 1 - MAST HEIGHT *

Max. Travel mm (inches)	Extension Height mm (inches)		Mast Height Approx with Gate with 4.788" CAP	
	1778 (70")	1168 (46")	254 (10")	254 (10")
1219 (48")	1	2748	108.188	
1524 (60")	1	3053	120.188	
1829 (72")	1	3662	144.188	
2438 (96")	1	4272	168.188	
2743 (108")	1	4272	168.188	
3048 (120")	2	4882	192.188	
3658 (144")	2	5440	214.188	
4267 (168")	2	6050	238.188	
4877 (192")	2	6660	262.188	
5486 (216")	3	7269	286.188	
6096 (240")	3	7828	308.188	
6706 (264")	3	8438	332.188	
7010 (276")	3	8692	342.188	

*EXAMPLE TABLE WITH 3" PIT. DIMENSIONS VARY WITH TRAVEL.

TABLE 2 - ENCLOSURE DIMENSION

CLEAR INSIDE CAB WIDTH	CLEAR INSIDE CAB LENGTH		FINISHED RUNWAY WIDTH		FINISHED RUNWAY LENGTH		TOWER CENTER LINE	DOOR CENTER LINE (IN CASE OF 38" DOOR)	DOOR CLEARANCE
	mm	Inches	mm	Inches	mm	Inches			
914	36	1219	48	56	1437	58	697	27	1100
914	36	1372	54	56	1437	64	754	30	1100
1067	42	1219	48	62	1590	58	697	27	1253
1067	42	1372	54	62	1590	64	754	30	1253
1067	42	1524	60	62	1743	70	840	33	1253

Figure 23: Auto door, left-hand

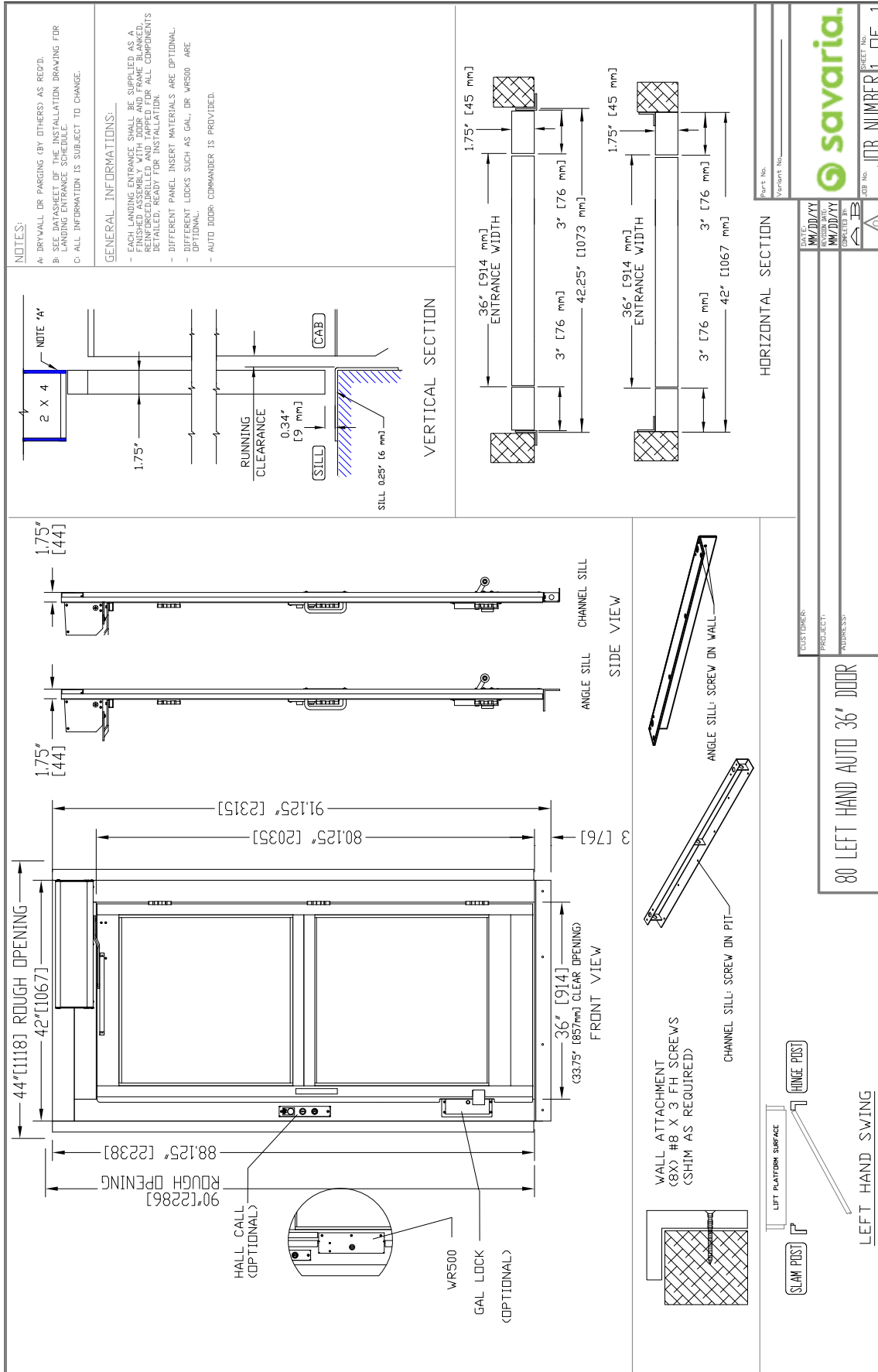

Figure 24: Auto door, right-hand

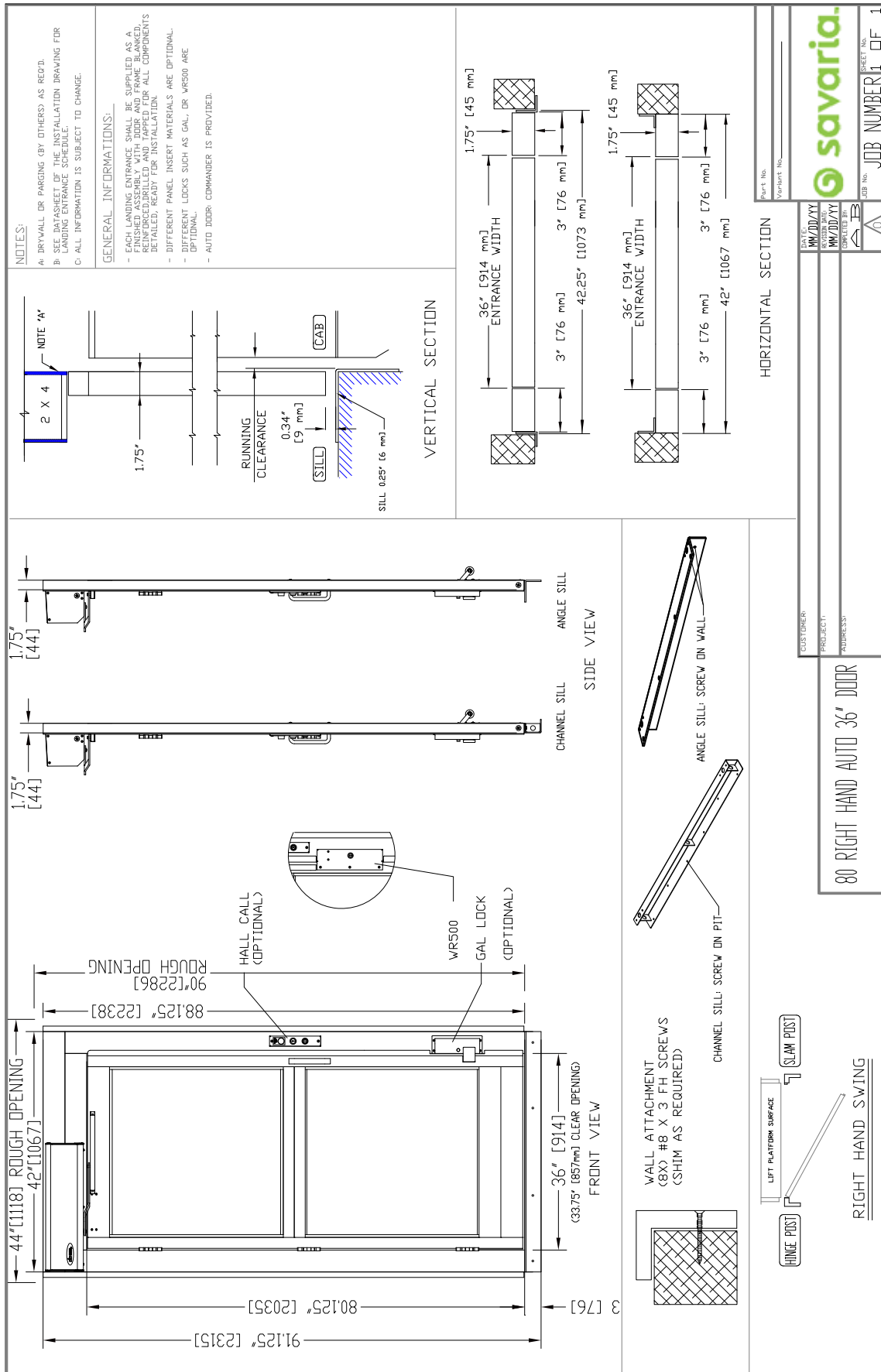

Figure 25: Manual door, left-hand

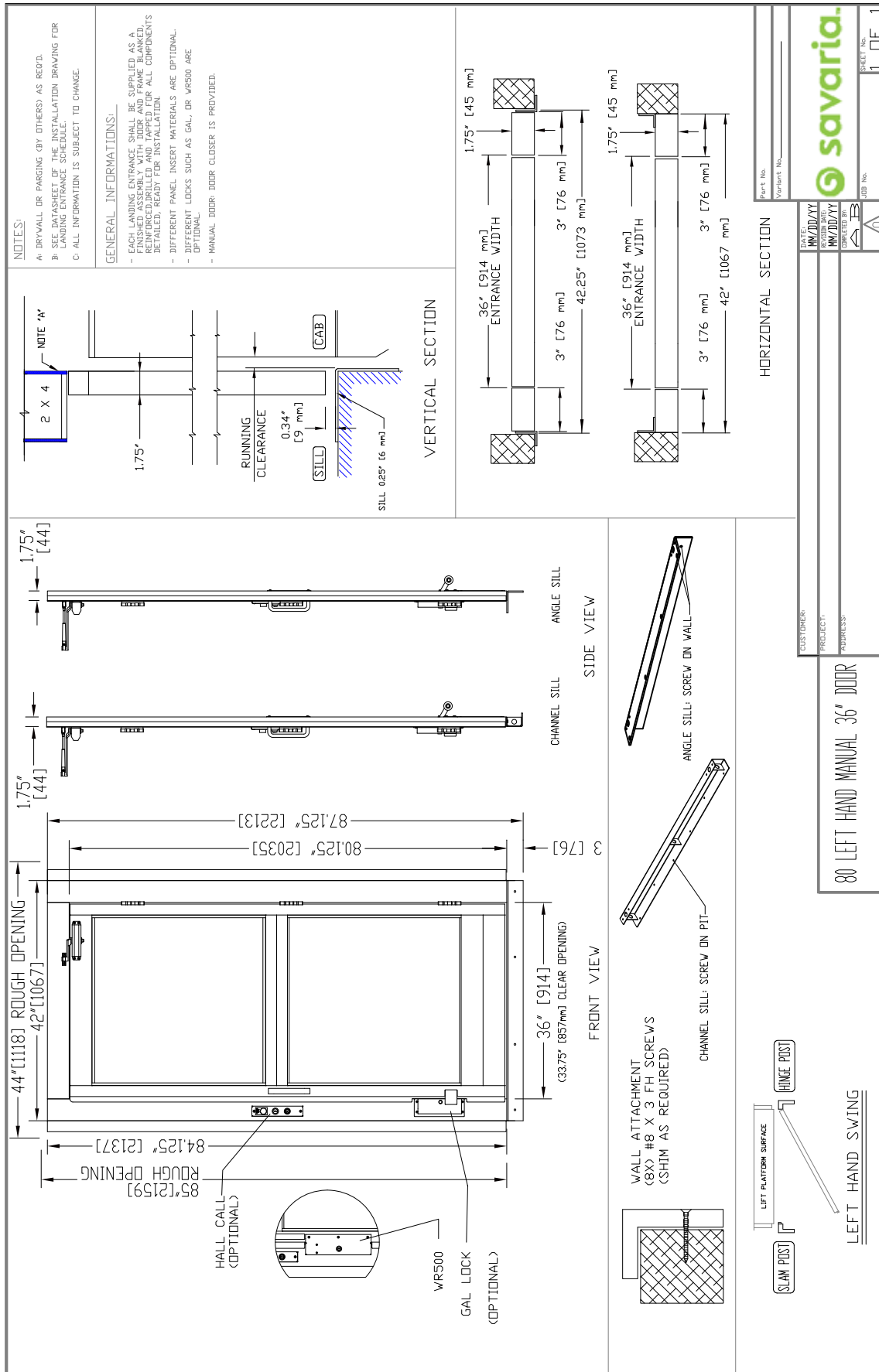

Figure 26: Manual door, right-hand

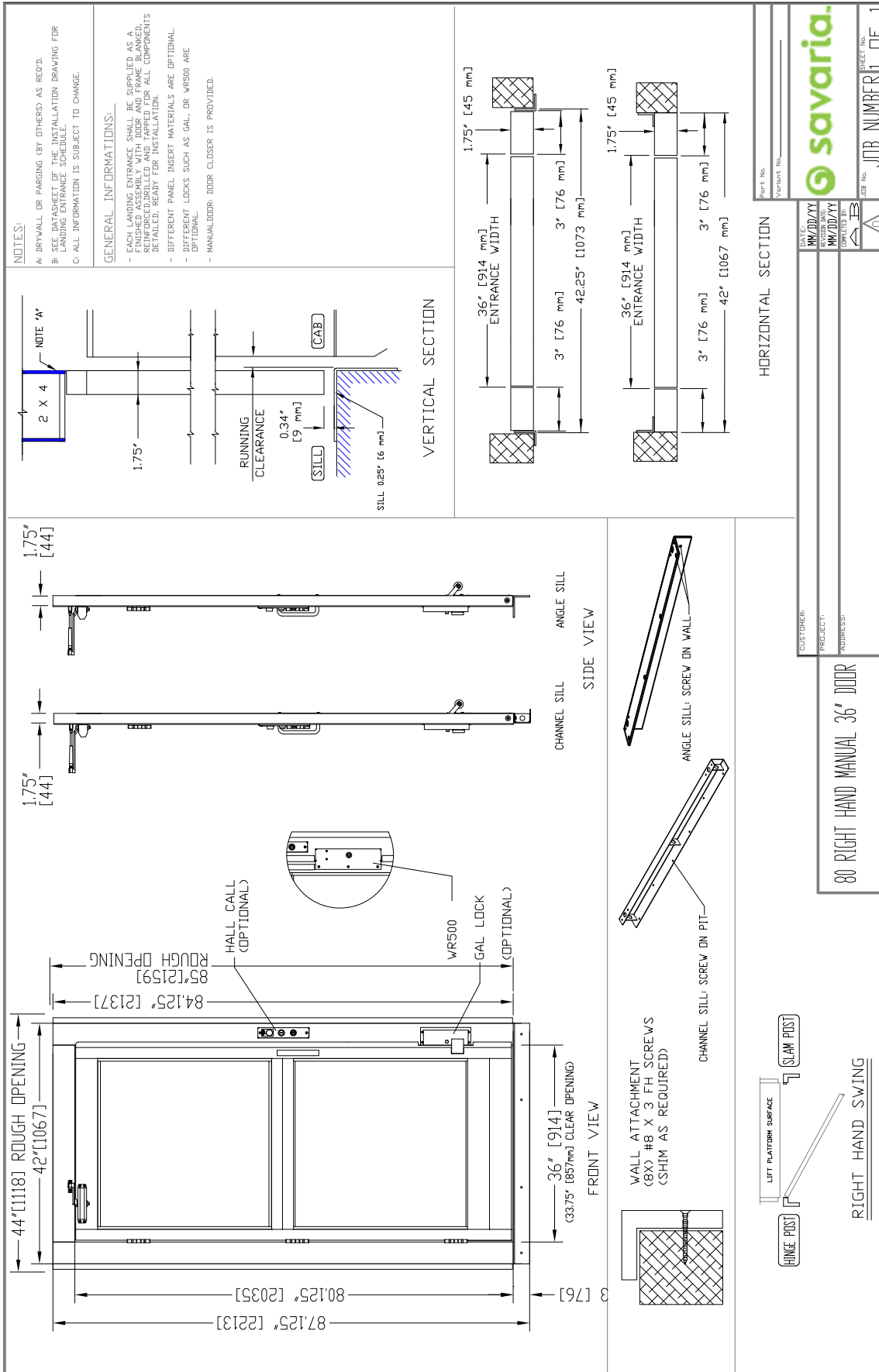

Figure 27: Prodoor auto, left-hand

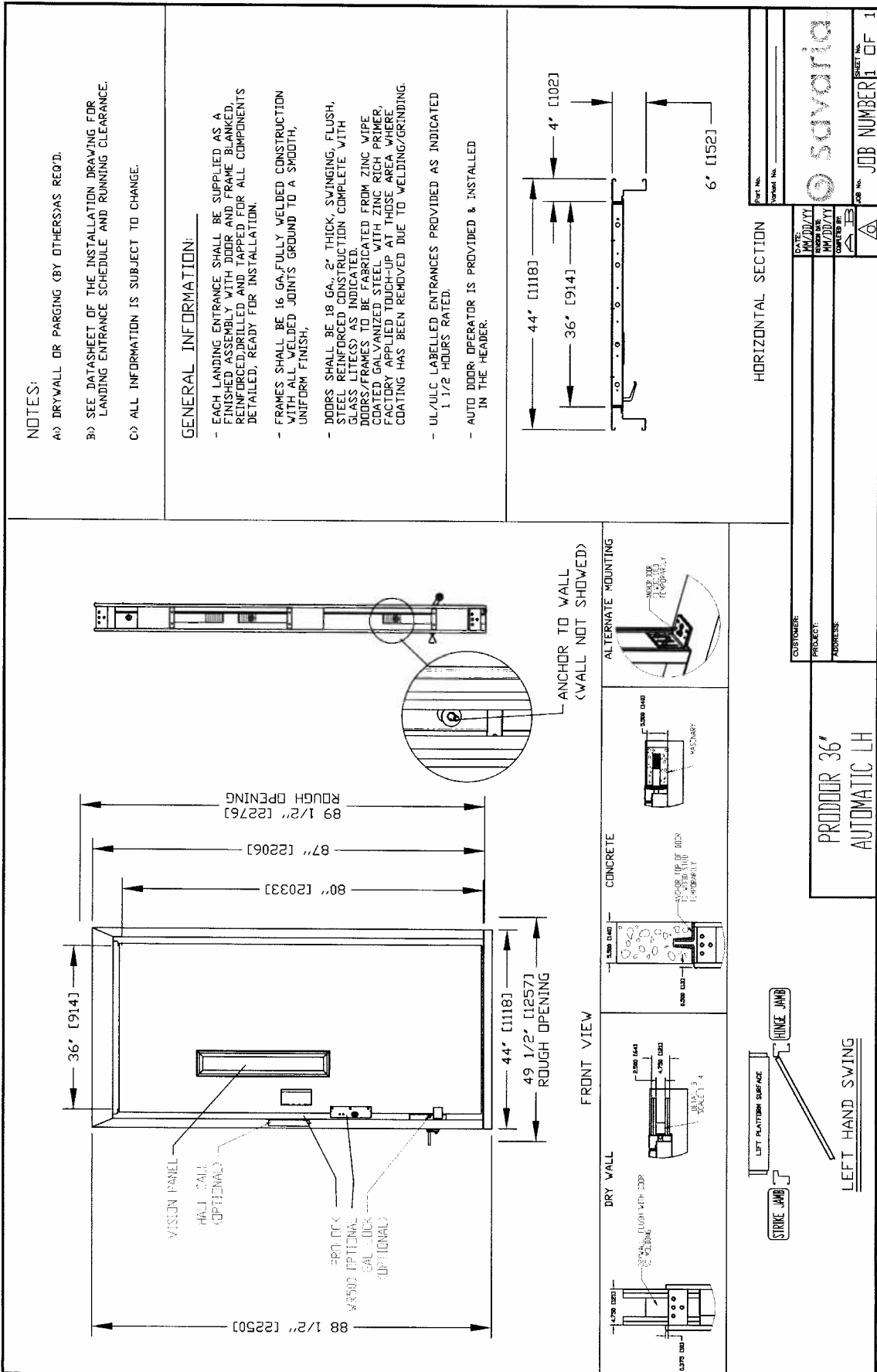

Figure 28: Prodoor auto, right-hand

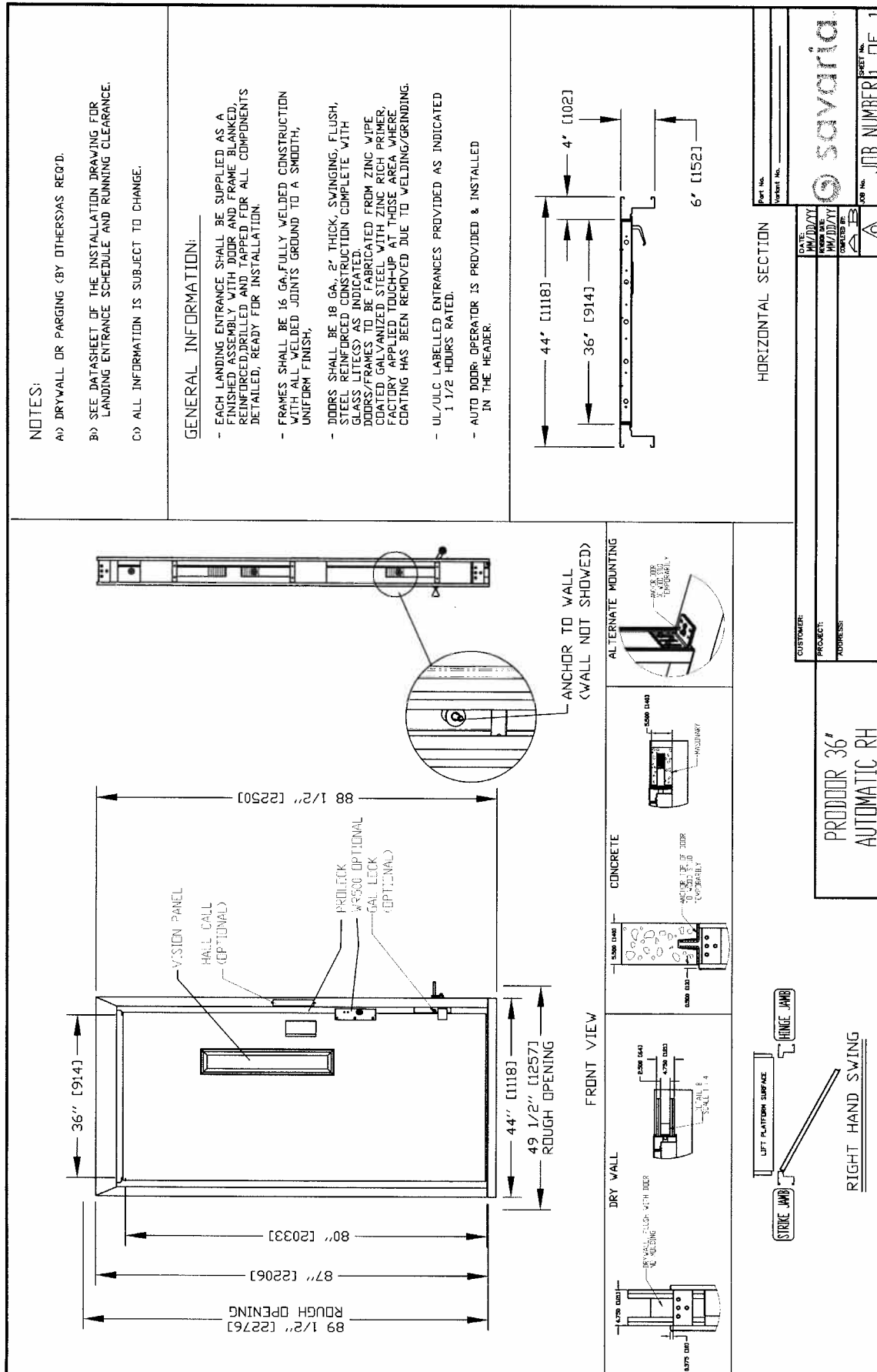

Figure 29: Prodoor manual, left-hand

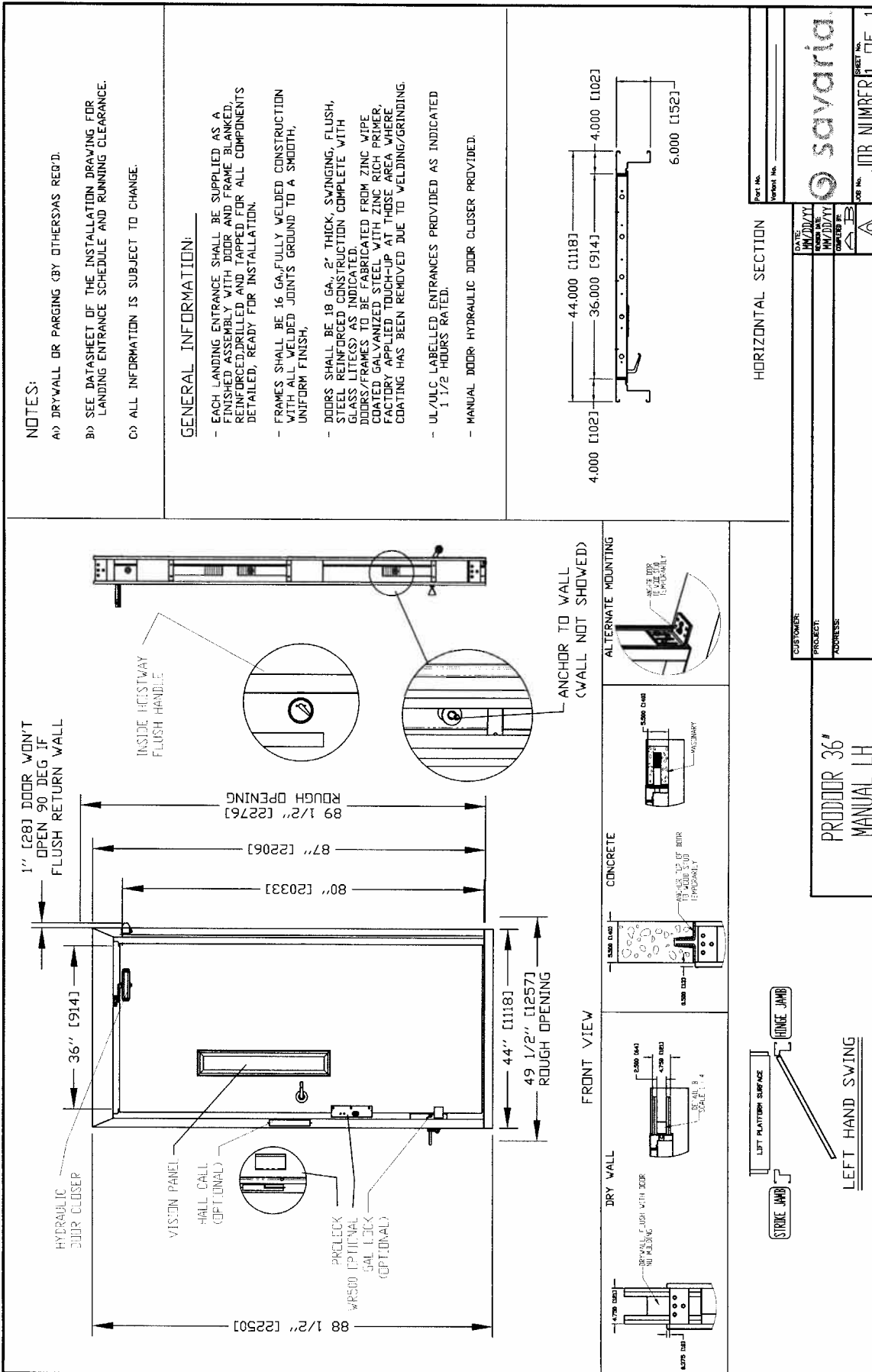

Figure 30: Prodoor manual, right-hand

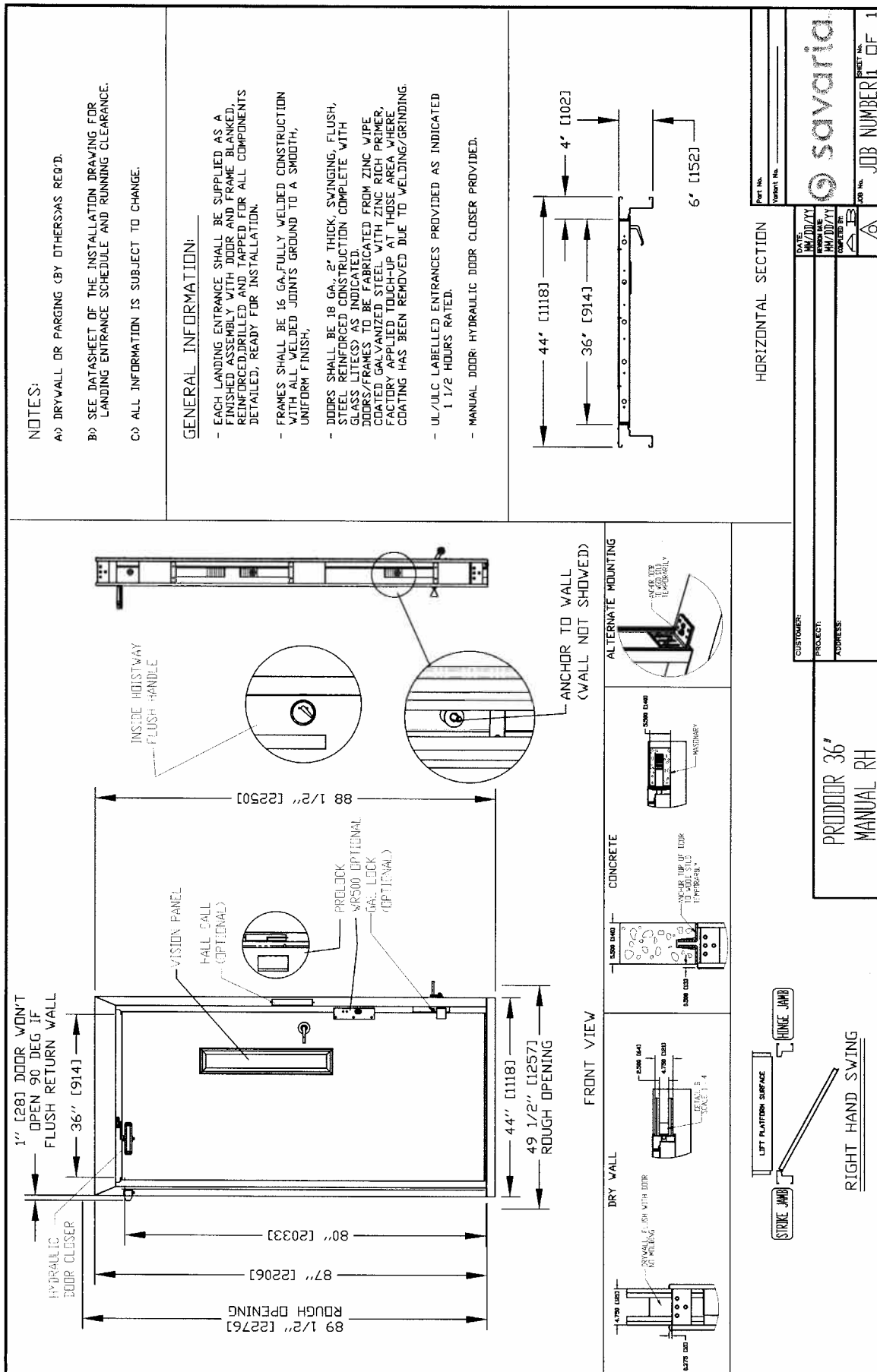

Figure 31: Prodoor installation (drywall)

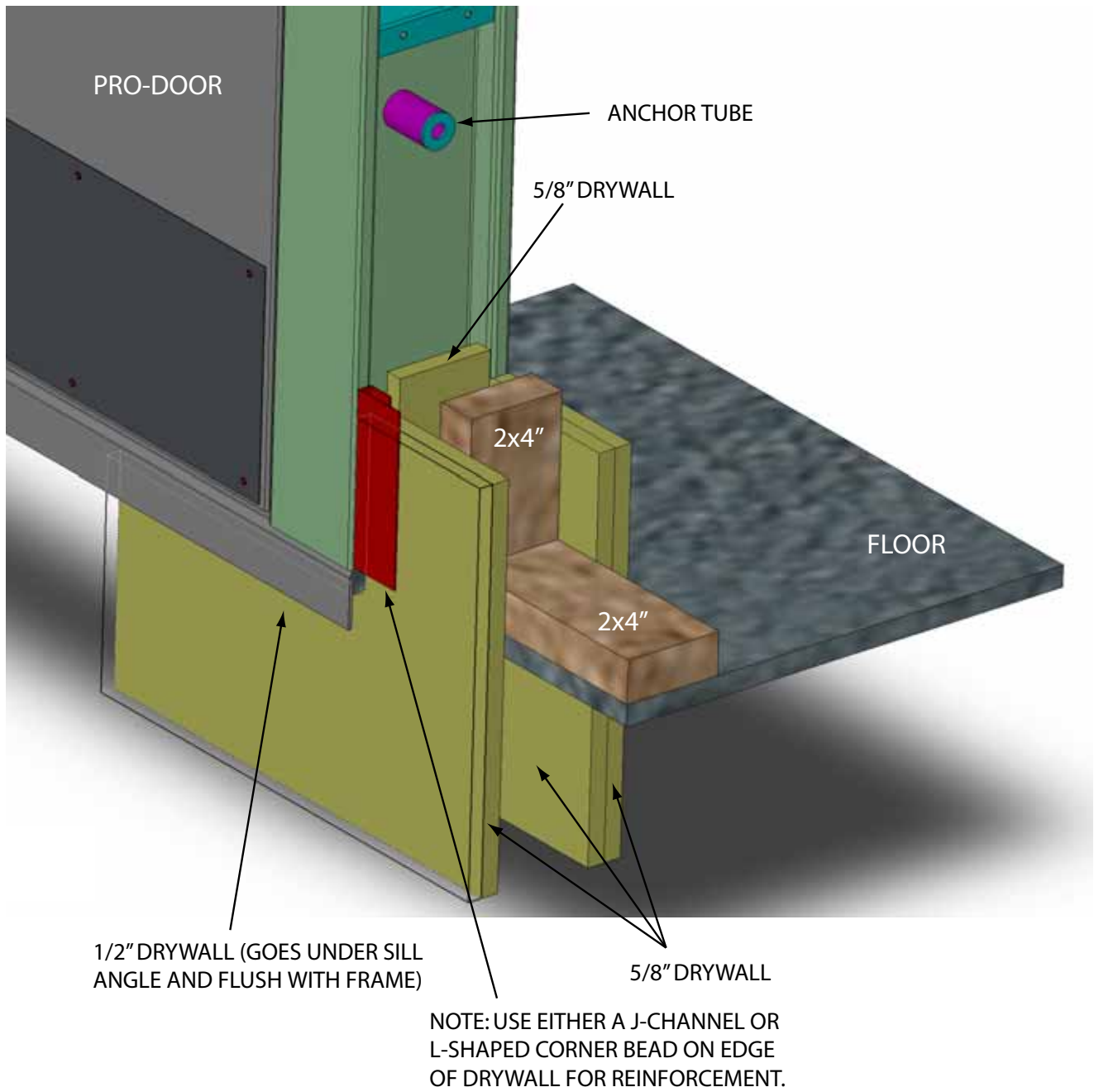

Figure 32: Auto half gate, left-hand

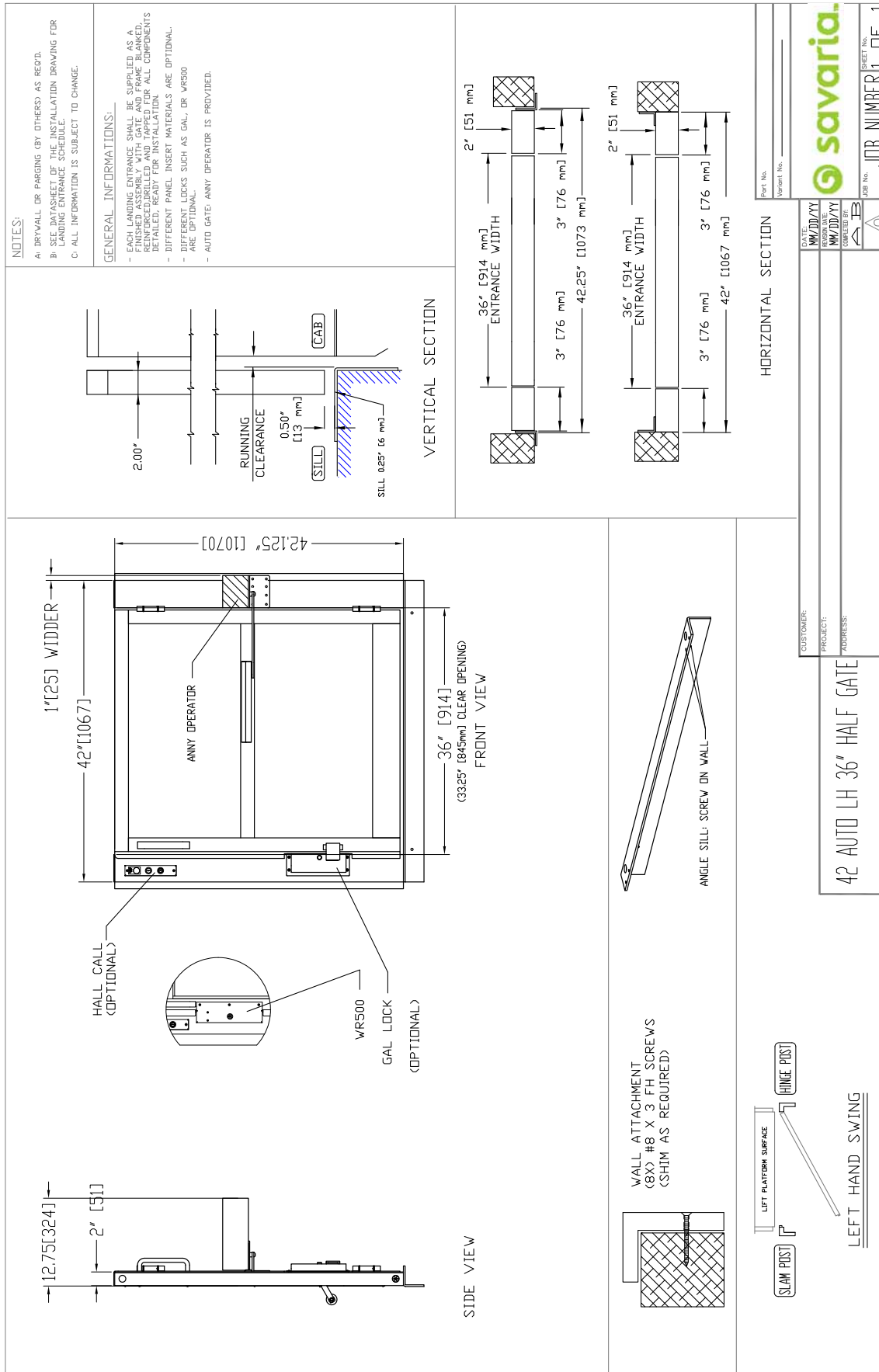

Figure 33: Auto half gate, right-hand

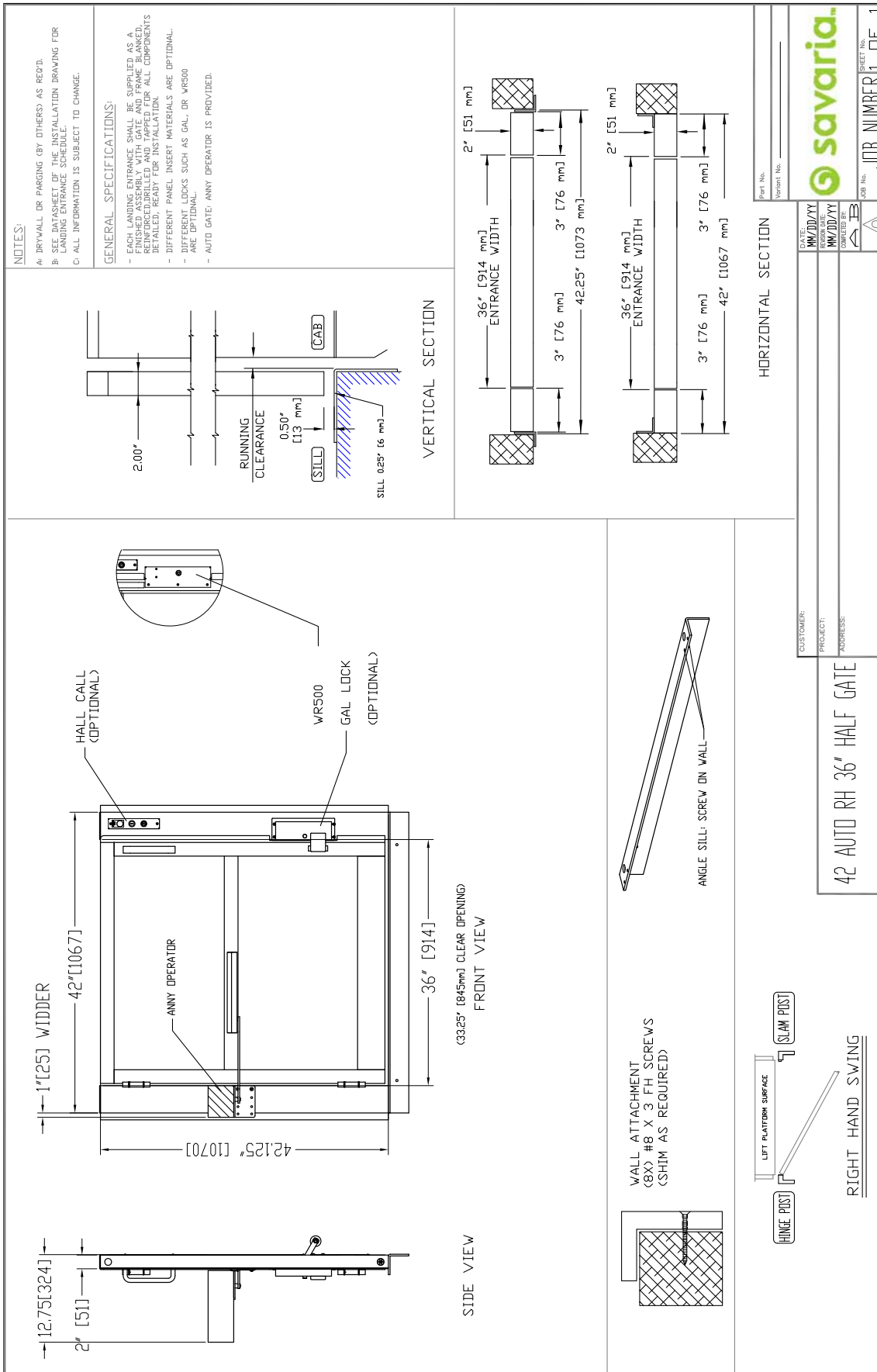

Figure 34: Manual half gate, left-hand

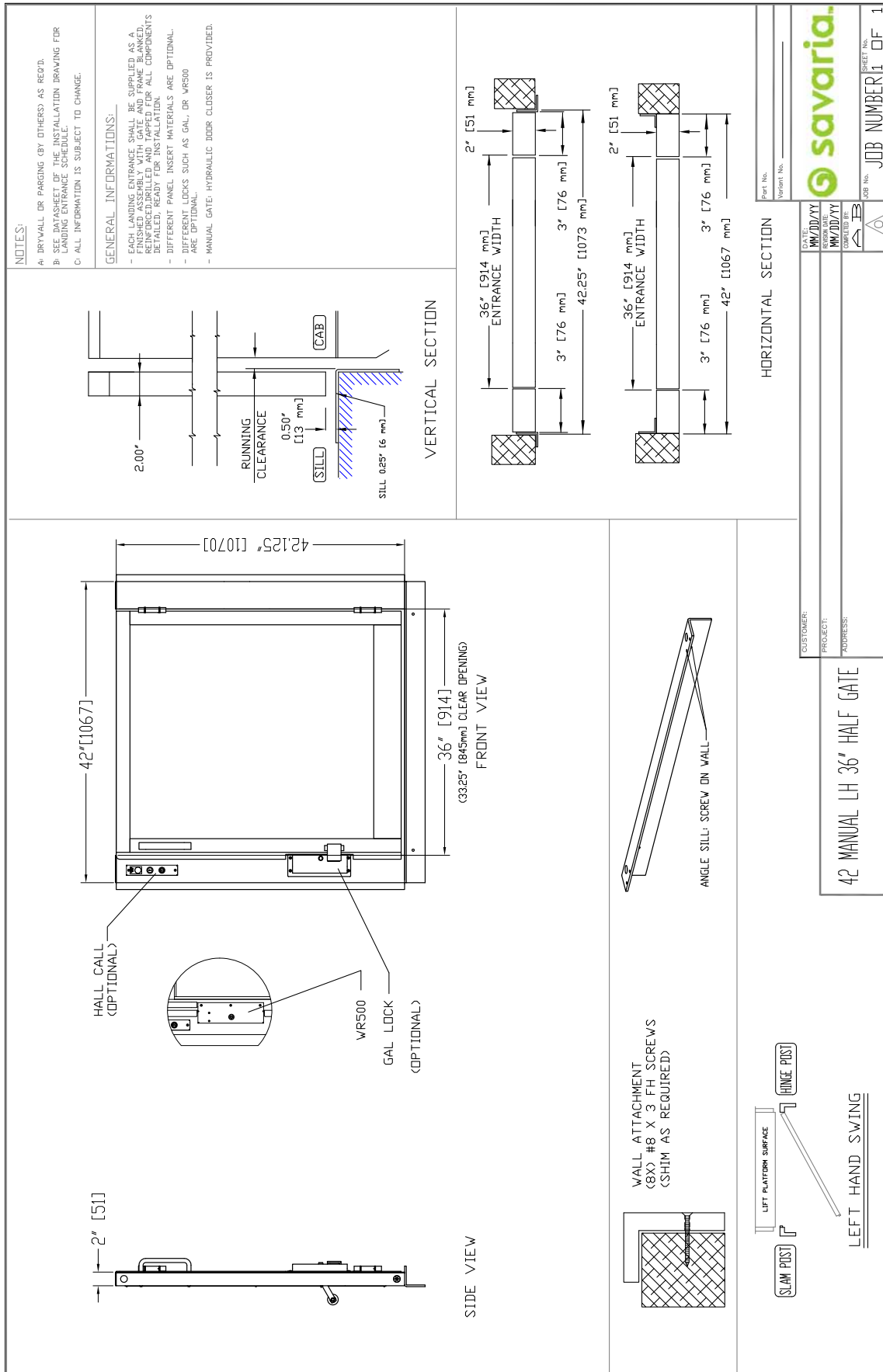

Figure 35: Manual half gate, right-hand

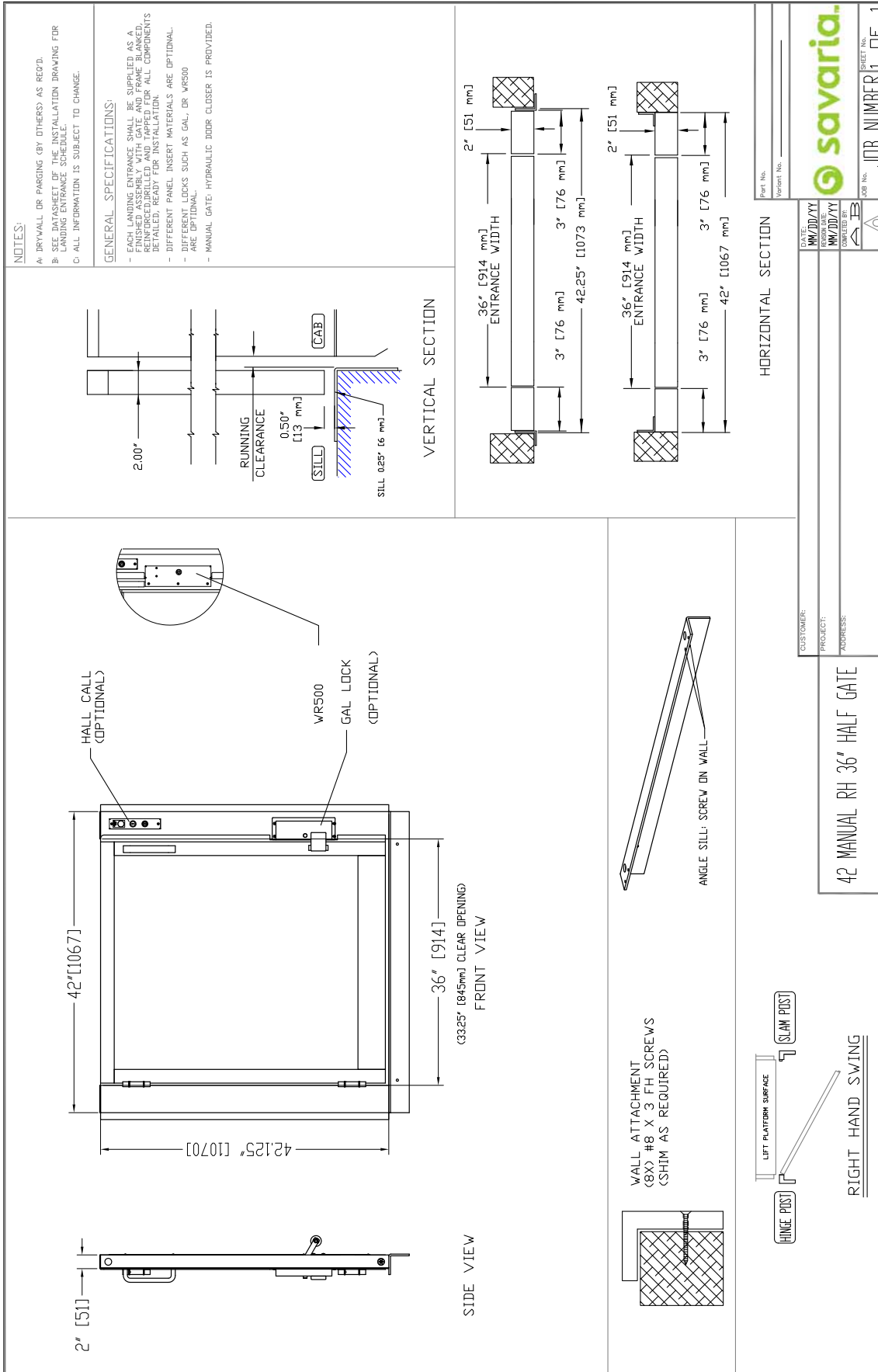

Figure 36: DuraSwing on half gate, right-hand

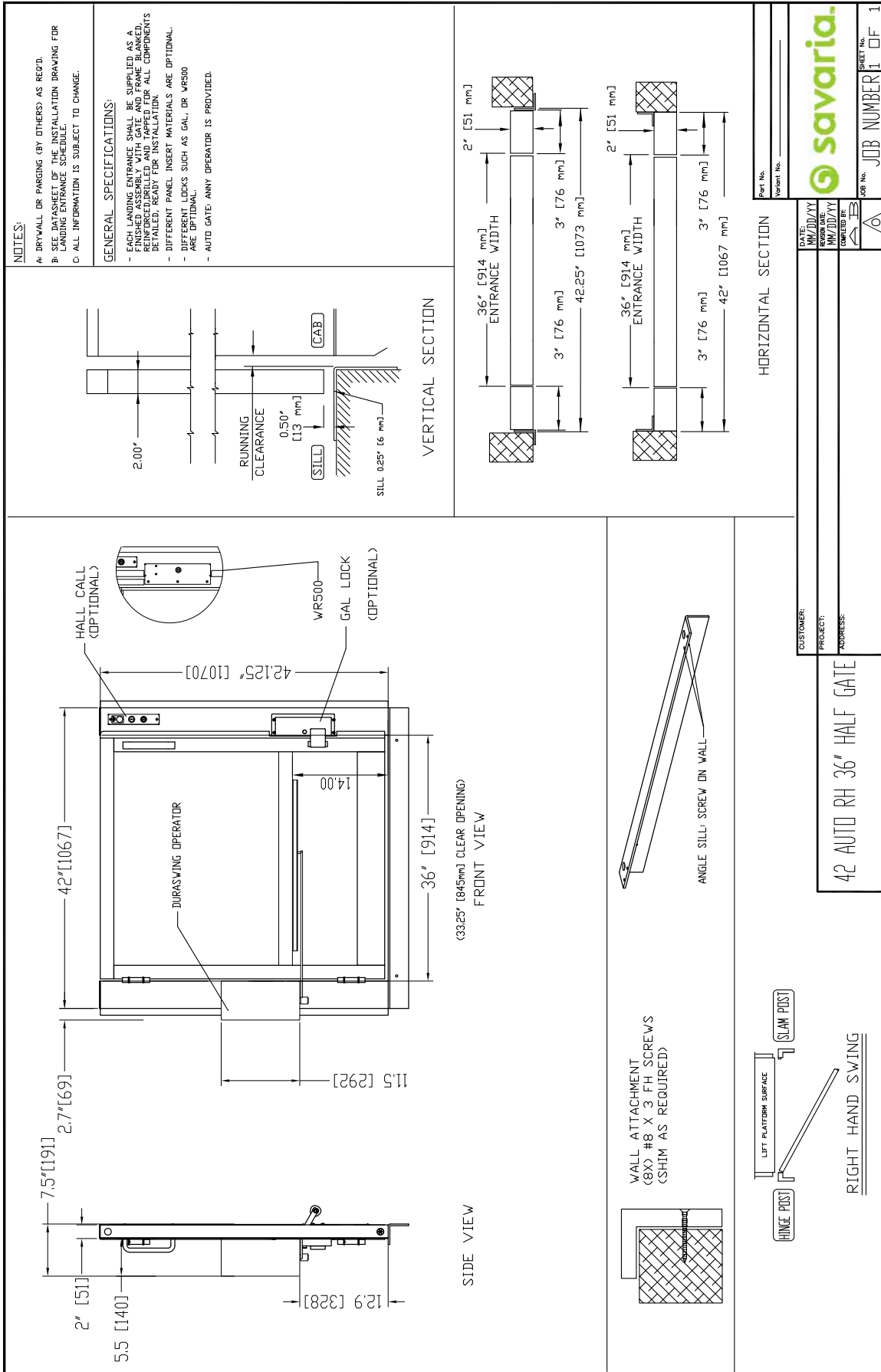

Figure 37: DuraSwing on half gate, right-hand, 45" opening

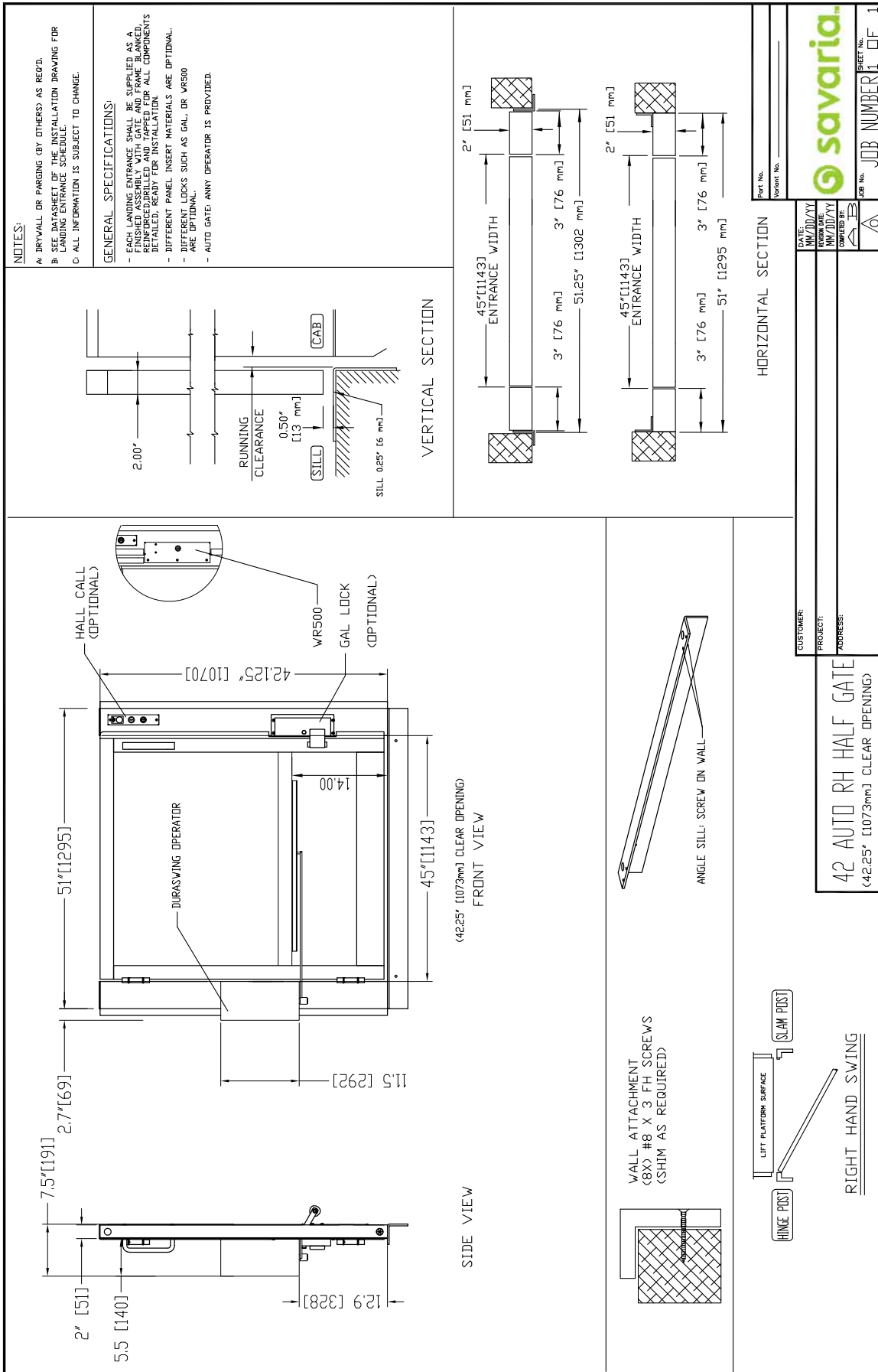

Figure 38: DuraSwing on half gate, left-hand

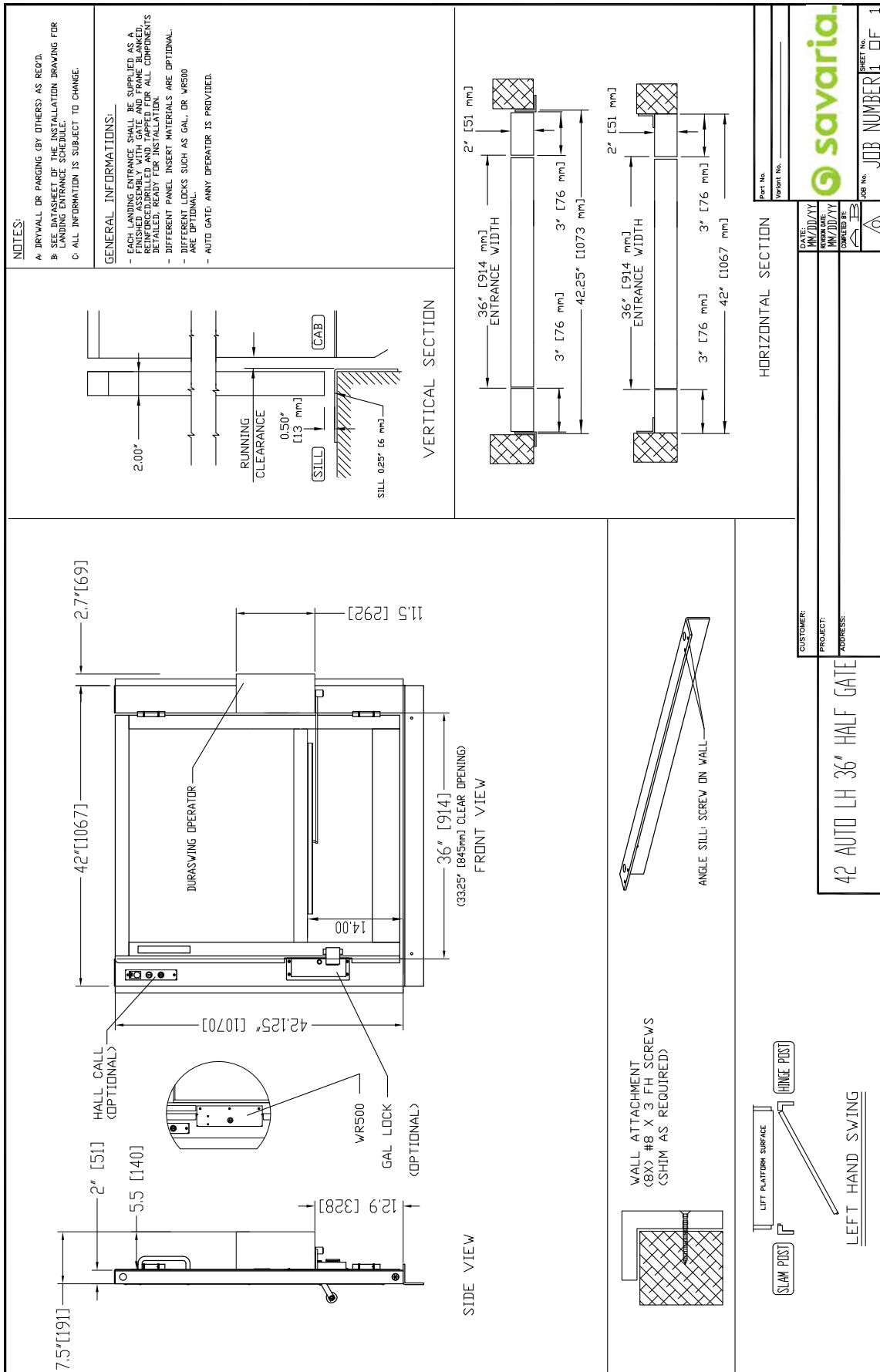

Figure 39: DuraSwing on half gate, left-hand, 45" opening

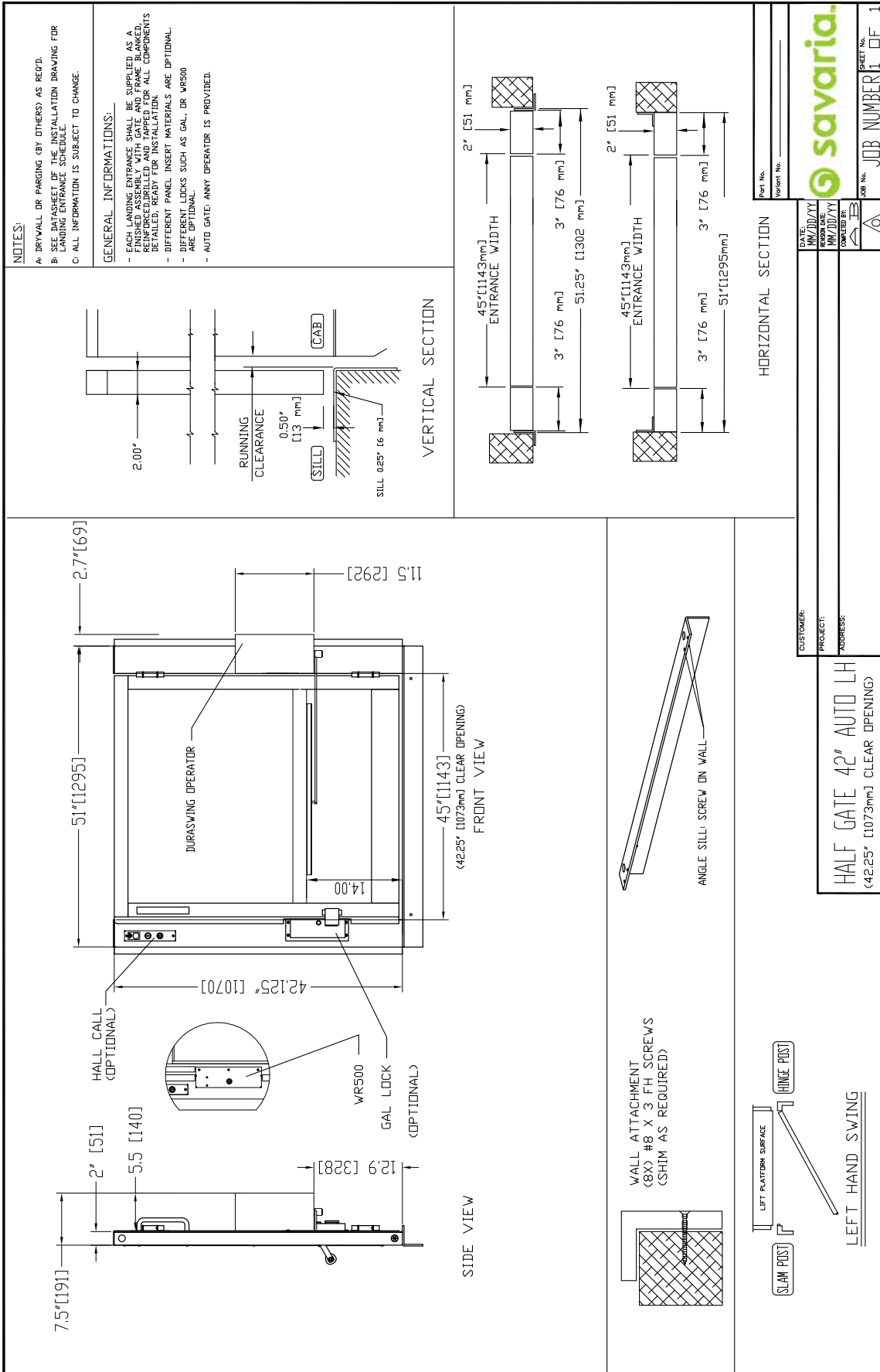
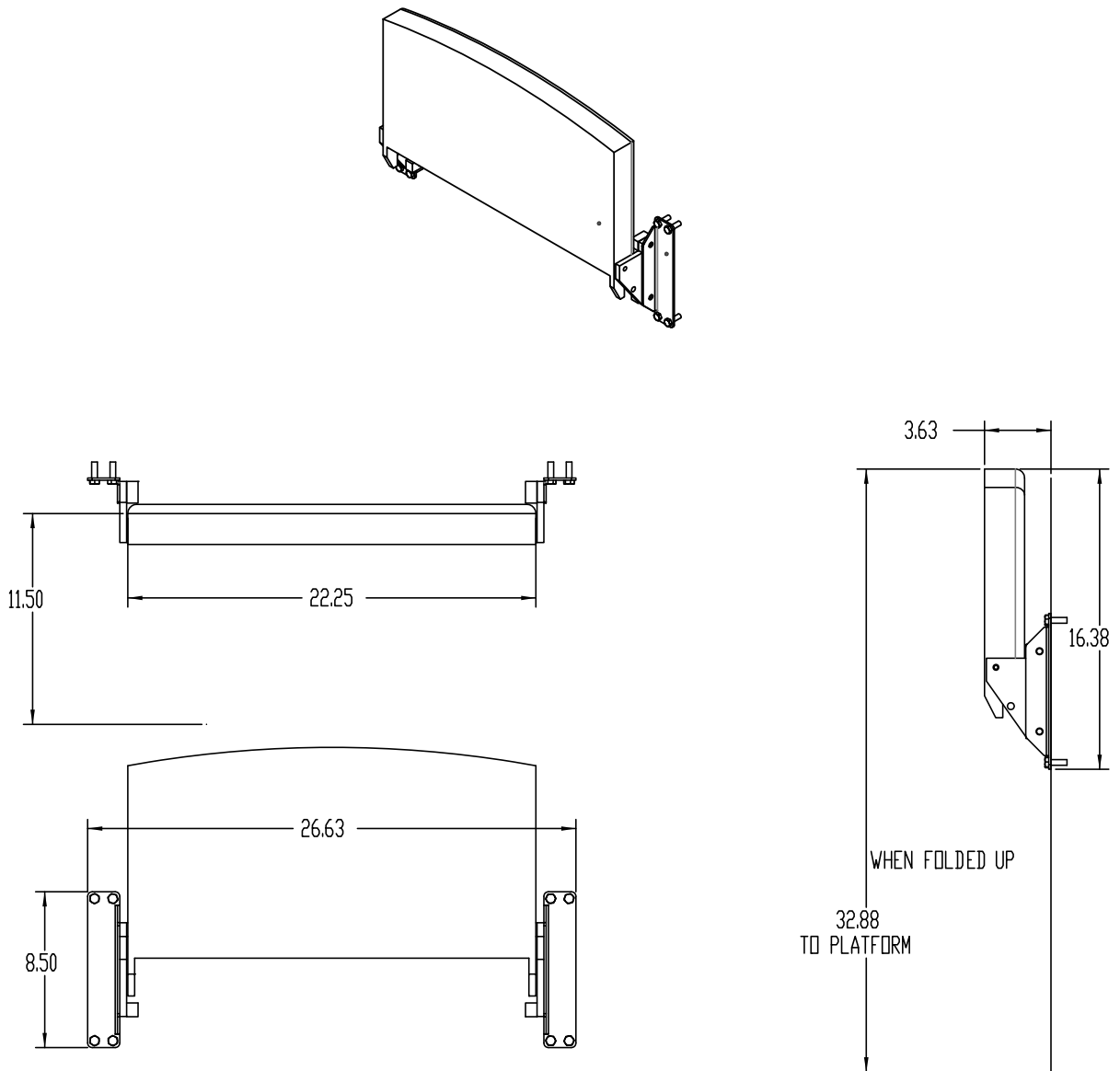
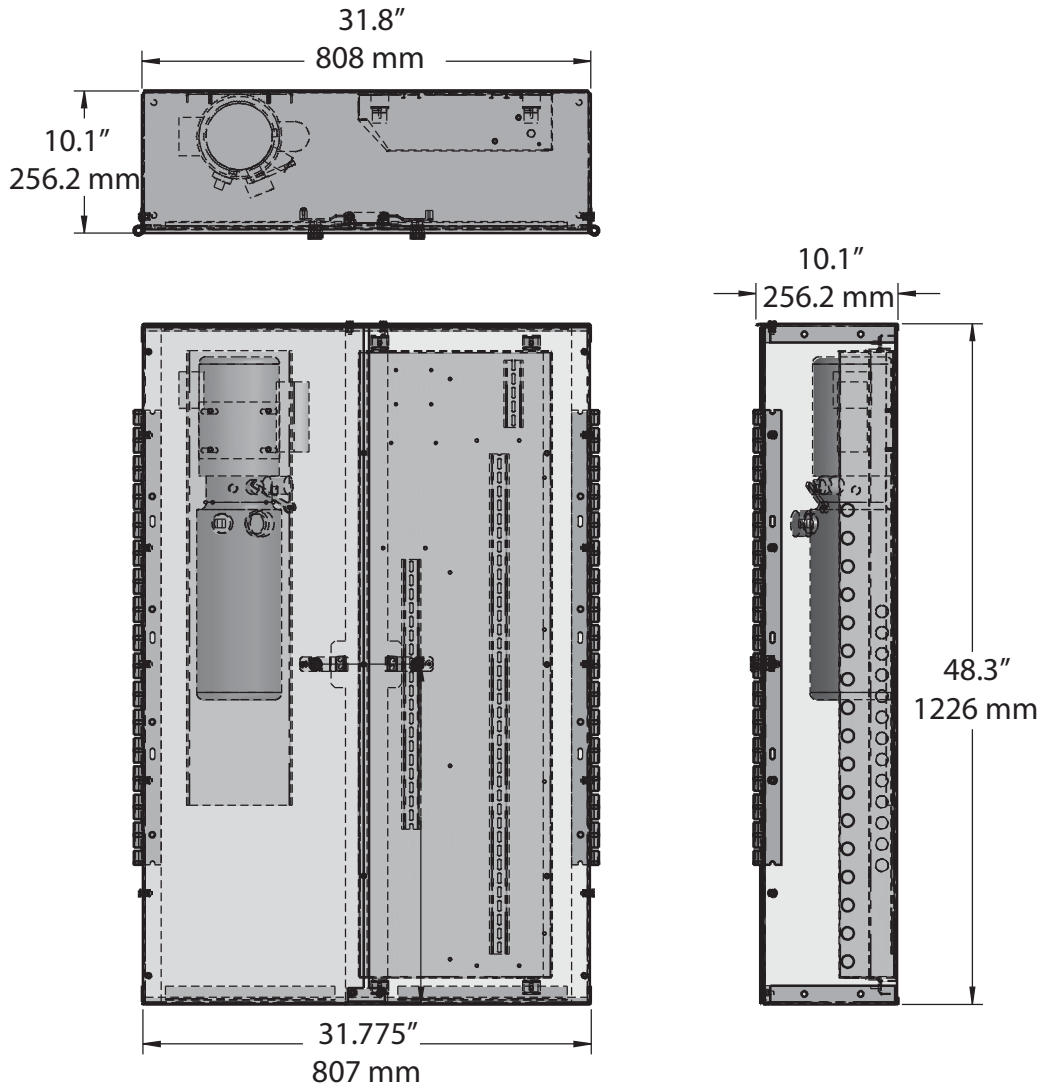

Figure 40: Seat dimensions



NOTE: Maximum seat capacity is 330 lbs (150 kg)

Figure 41: Remote controller/pump box dimensions



PROVISIONS BY OTHERS

GENERAL REQUIREMENTS

Hoistway

The hoistway must be designed and built in accordance with the “safety standard for platform lifts and stairway chairlifts” or the “safety code for elevators and escalators” and all state and local codes.

Plumb Runway

Due to close running clearances, the owner/agent must ensure that the hoistway and the pit (where provided) are level, plumb and square and are in accordance with the dimensions on the installation drawings.

Minimum Overhead Clearance

The owner/agent must ensure the minimum overhead clearance is in compliance with codes.

Construction Site

The owner/agent is required to provide all masonry, carpentry and drywall work as required and shall patch and make good (including finish painting) all areas where walls/floors may need to be cut, drilled or altered in any way to permit the proper installation of the lift.

Dimensions

The contractor/customer is required to verify all dimensions and report any discrepancies to our office immediately.

STRUCTURAL REQUIREMENTS

Floor/Support Wall Loads

The structural engineer is to ensure that the building and shaft will safely support all loads imposed by the lift equipment. Refer to the installation drawings for the loads imposed by the equipment.

Mast to be Securely Fastened

Where required, the mast must be securely fastened to the structural support wall. Refer to the installation drawings for the loads imposed by the equipment.

Where Doors are Required

Suitable lintels must be provided by the owner/agent. Door frames are not designed to support overhead wall loads.

ELECTRICAL REQUIREMENTS

General

Electrical equipment and wiring must comply with Section 38 of CSA C22.1 (Canada) or Section 620 of NEC ANSI NFPA 70 (USA).

Power Supply

A 120 VAC, 20A, 60 Hz, single-phase circuit through a fused disconnect with an auxiliary contact on the main power supply is required.

Lighting

Lighting of 100 lux minimum is required at platforms and landings. Lighting with a switch and electrical GFCI outlet is required in the hoistway pit.

Additional Branch Circuit

Branch circuit with disconnect for door operators, if equipped (120VAC, 15A, 60HZ, 1PH). Branch circuit with disconnect for ventilation system, if equipped (120VAC, 15A, 60HZ, 1PH).

Branch Circuit for Hoistway Pit Lighting and Receptacles (Canada Only)

- a) A separate branch circuit shall supply the hoistway pit lighting and receptacles.
- b) Required lighting shall not be connected to the load side terminals of a ground fault circuit interrupter receptacle(s).
- c) A lighting switch shall be provided and shall be located so as to be readily accessible from the pit access door.
- d) At least one 125V, single-phase, duplex receptacle connected to a 15A branch circuit shall be provided in the hoistway pit.

ENTRANCE REQUIREMENTS

Upper Landing Gates

Where required, smooth solid barriers are to be supplied and installed on both sides of the entrance at the upper level and must be a minimum of 42" (1067 mm) high. The entrance assembly must be in place prior to this provision.

Fascia Panel Below Upper Level Entrance

Where required, fascia panel must be fastened to a solid wall and be perpendicular to the floor and walls. Hoistway fascia is not self-supporting for long, continuous runs void of entrances. Adequate support for the fascia must be provided.

Entrance Assemblies

Entrance assemblies must be adjusted to align with the platform and interlock equipment. Others must allow an adequate opening.

Return Walls

Return walls at the entrances must be built-in by others after the entrance assemblies are in place. The entrance assembly must be securely fastened to the walls by the contractor.

SAVARIA LINK OPTION

If you have the Savaria Link Ethernet remote monitoring option, ensure that you have an Ethernet connection with Internet capability in the vicinity of the unit's controller.

If you have the Savaria Link Wireless remote monitoring option, ensure that you have a wireless signal with Internet capability in the vicinity of the unit's controller.

V1504

Vertical Platform Lift

PLANNING GUIDE

Part No. 000690
Copyright © 2020

Savaria Concord Lifts, Inc.
www.savaria.com

Sales
2 Walker Drive
Brampton, Ontario L6T 5E1
Canada
Tel: (905) 791-5555
Fax: (905) 791-2222
Toll Free: 1-800-661-5112

